

 mundo primaria

# CUADERNO DE VACACIONES

*para Educación Infantil*

**50 FICHAS  
PARA TRABAJAR**

ATENCIÓN  
GRAFOMOTRICIDAD  
LECTURA  
NÚMEROS  
CÁLCULO  
ESCRITURA

[www.mundoprimary.com](http://www.mundoprimary.com)



**4-5  
AÑOS**



FICHAS PARA TRABAJAR  
**GRAFOMOTRICIDAD**

---



Repasa las líneas de puntos.

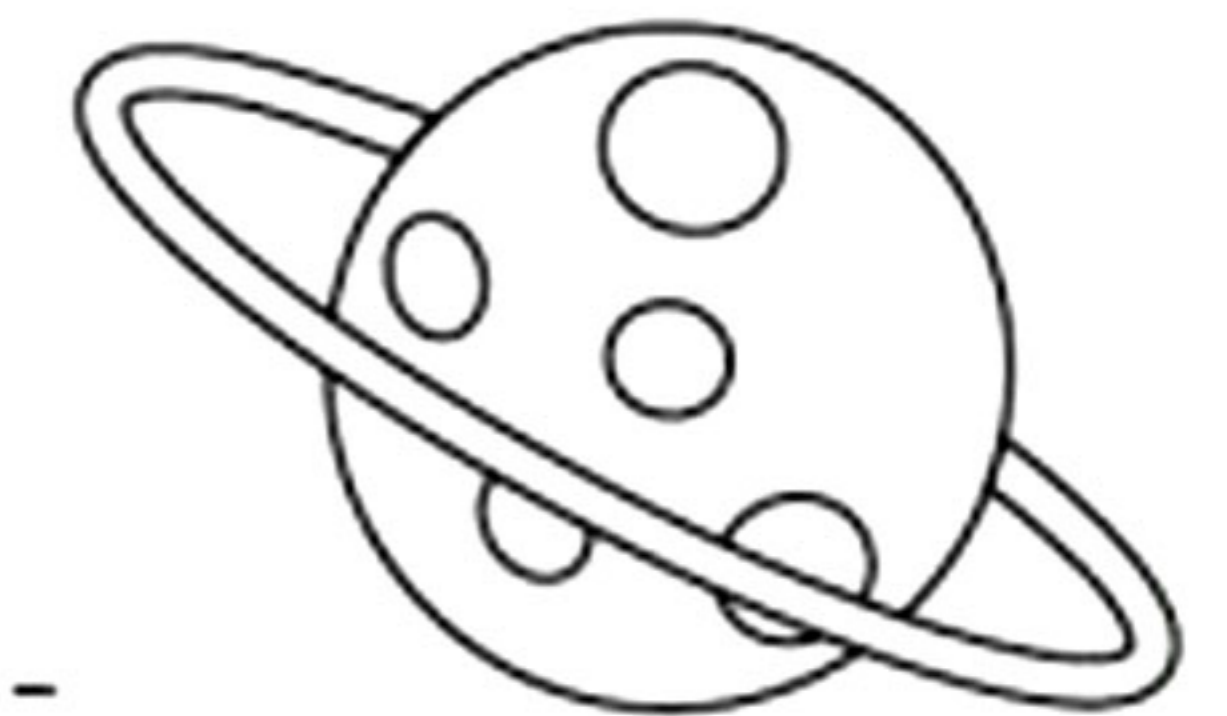
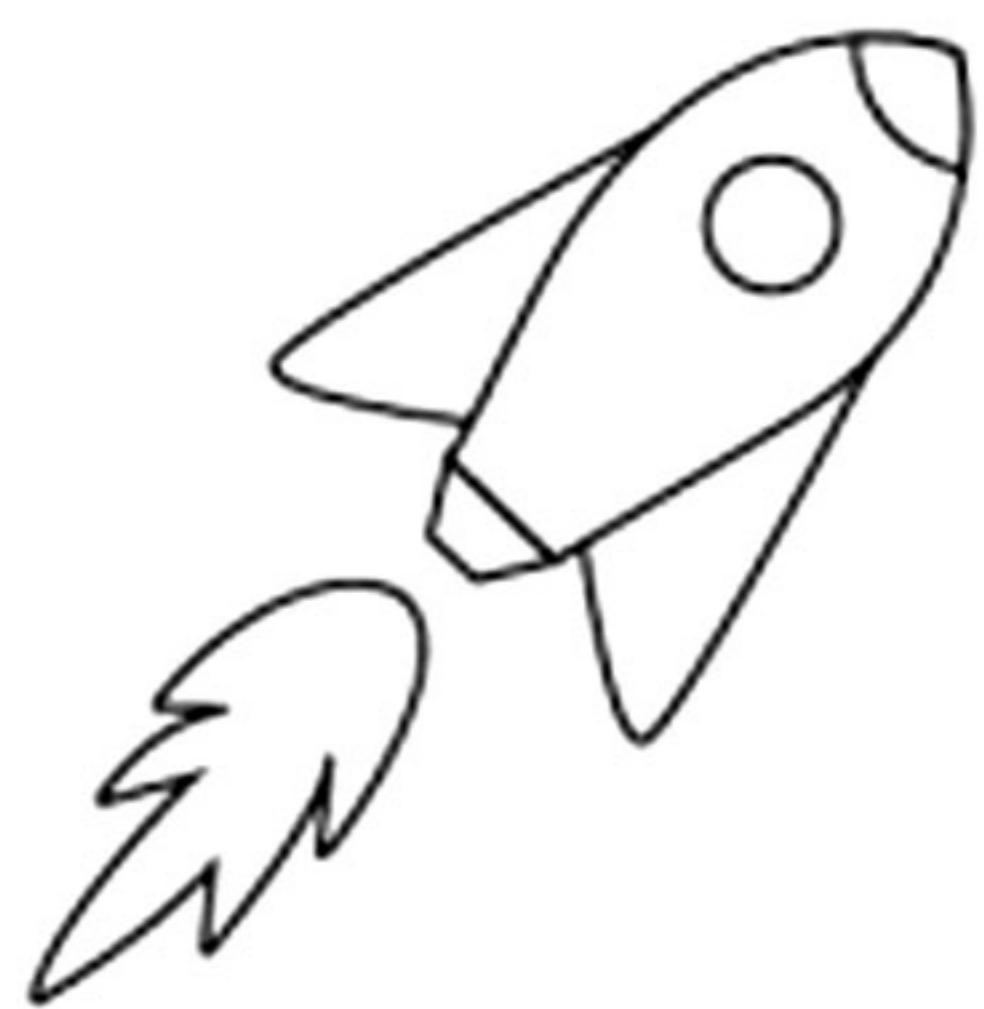
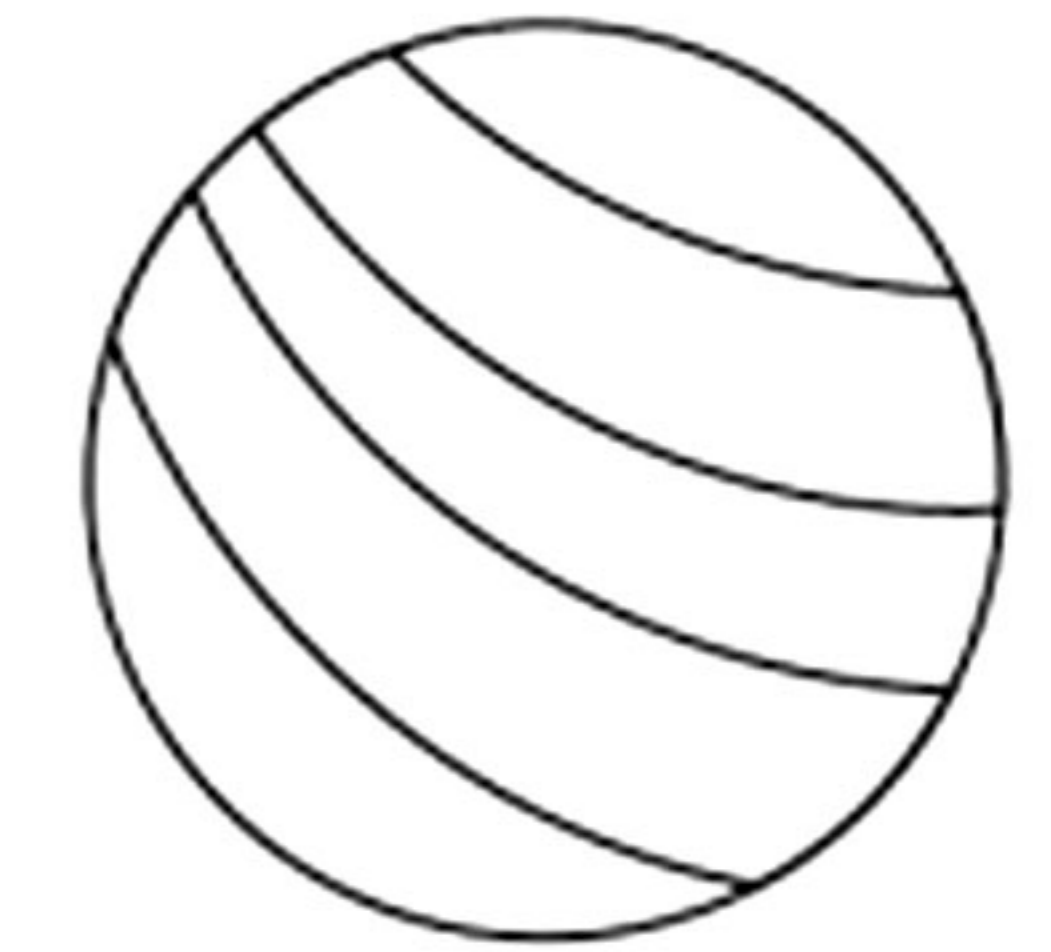
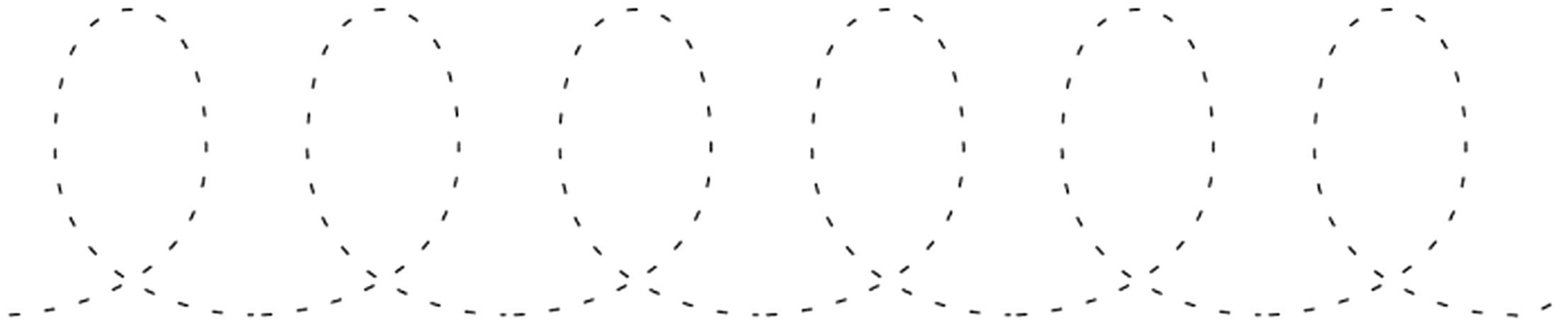



Completa los laberintos para unir los dibujos.

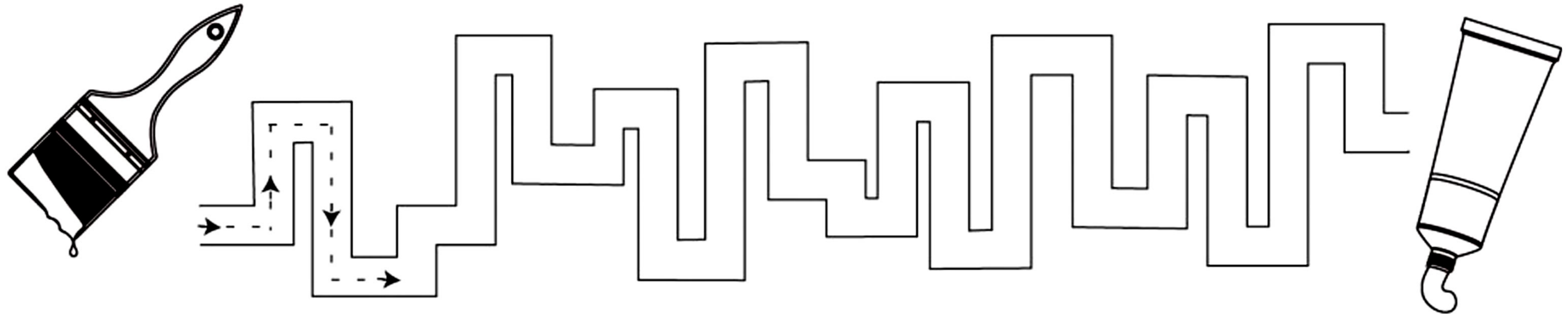
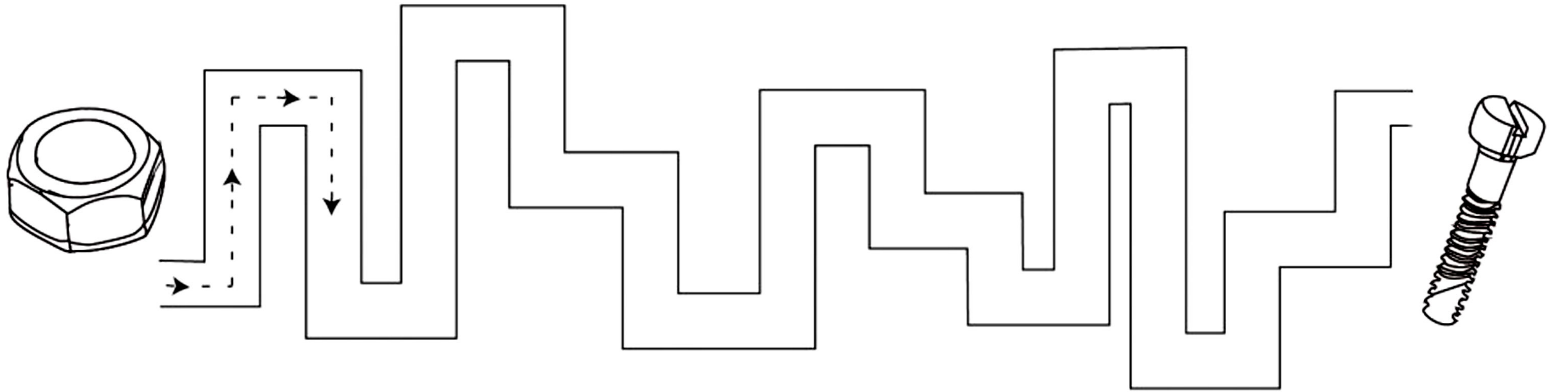



Completa los laberintos para unir los dibujos.

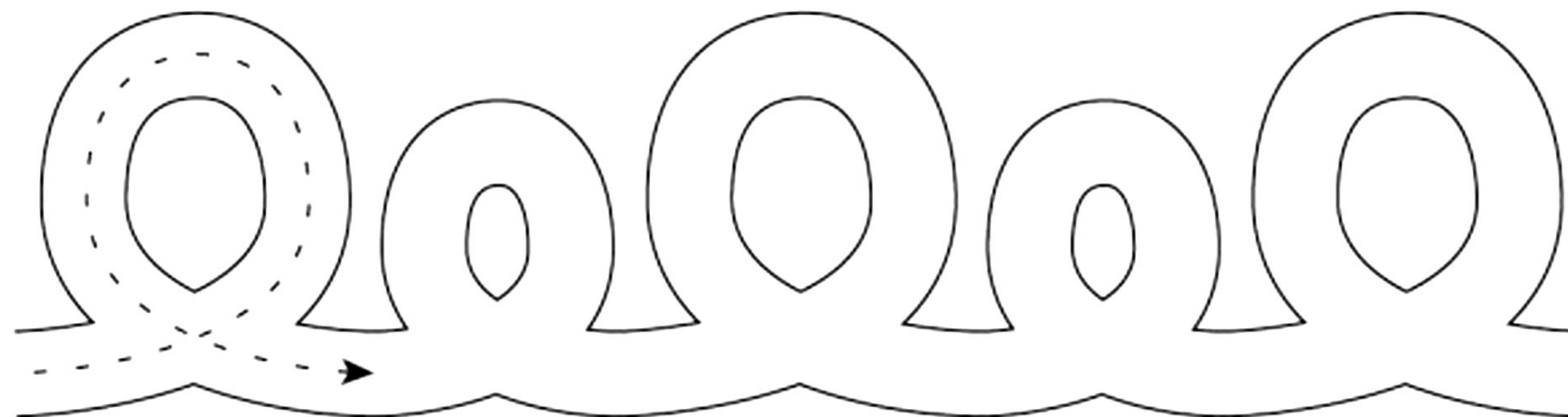
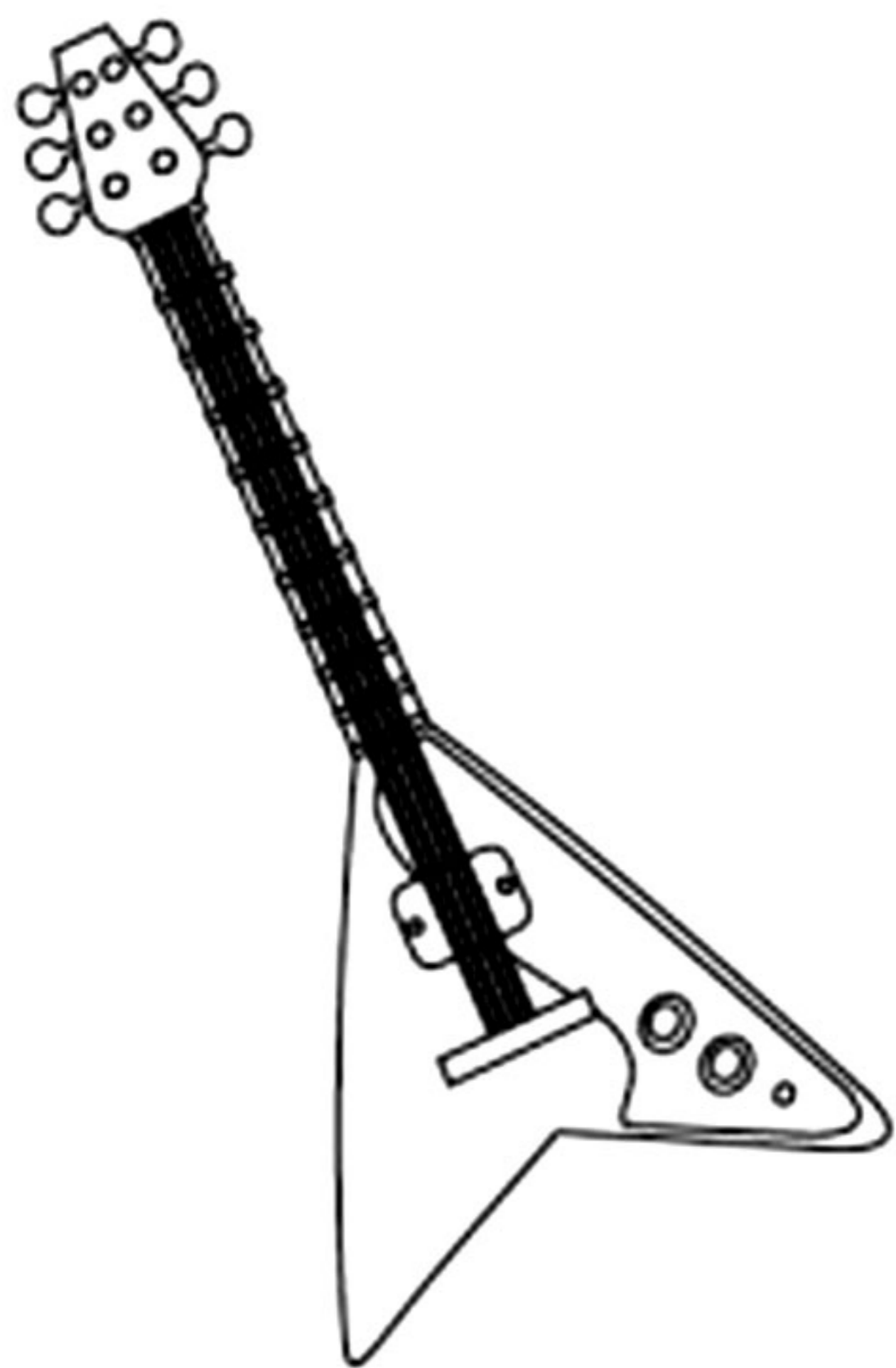
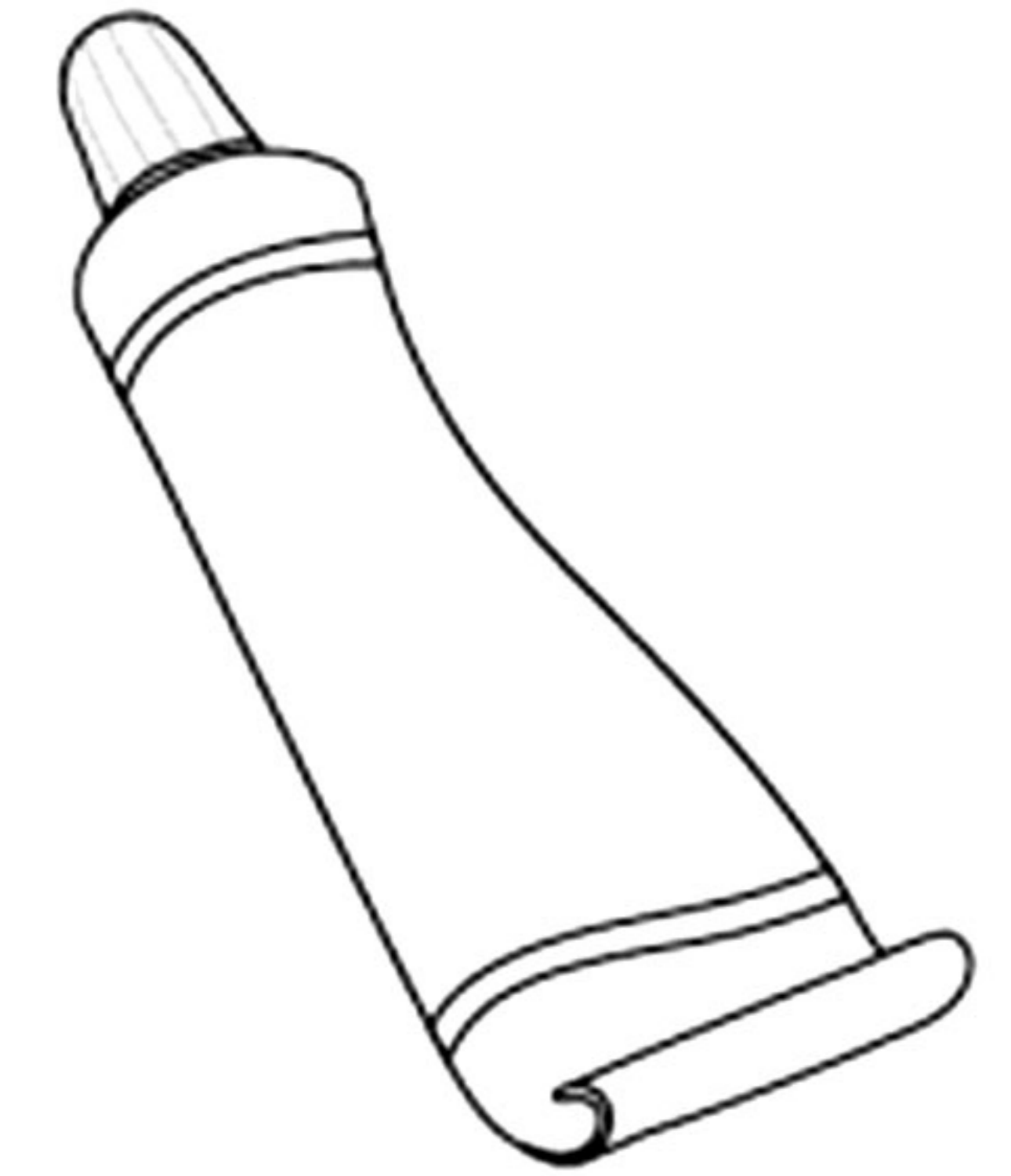
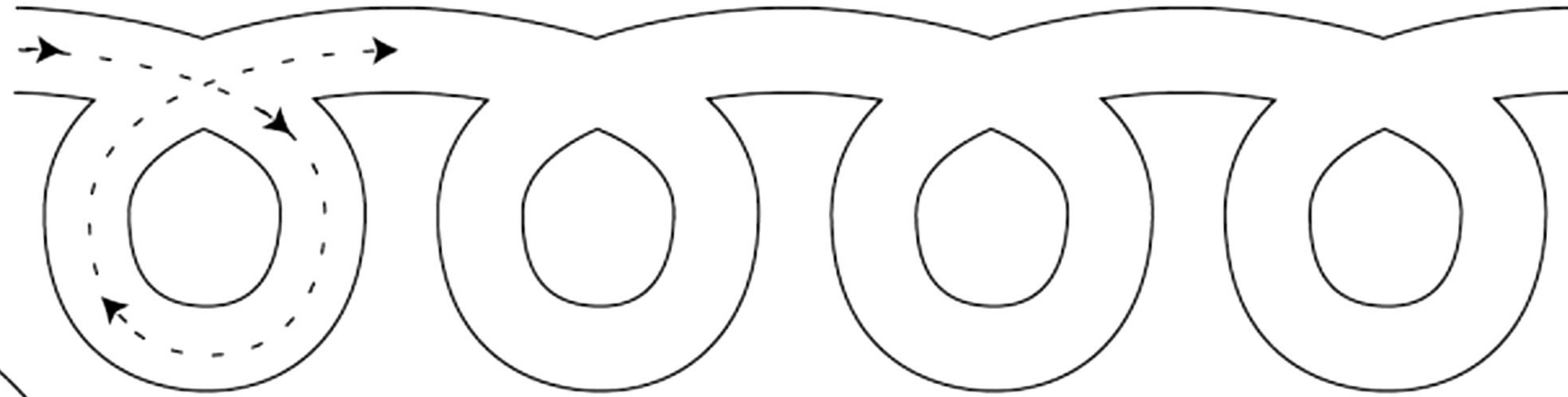
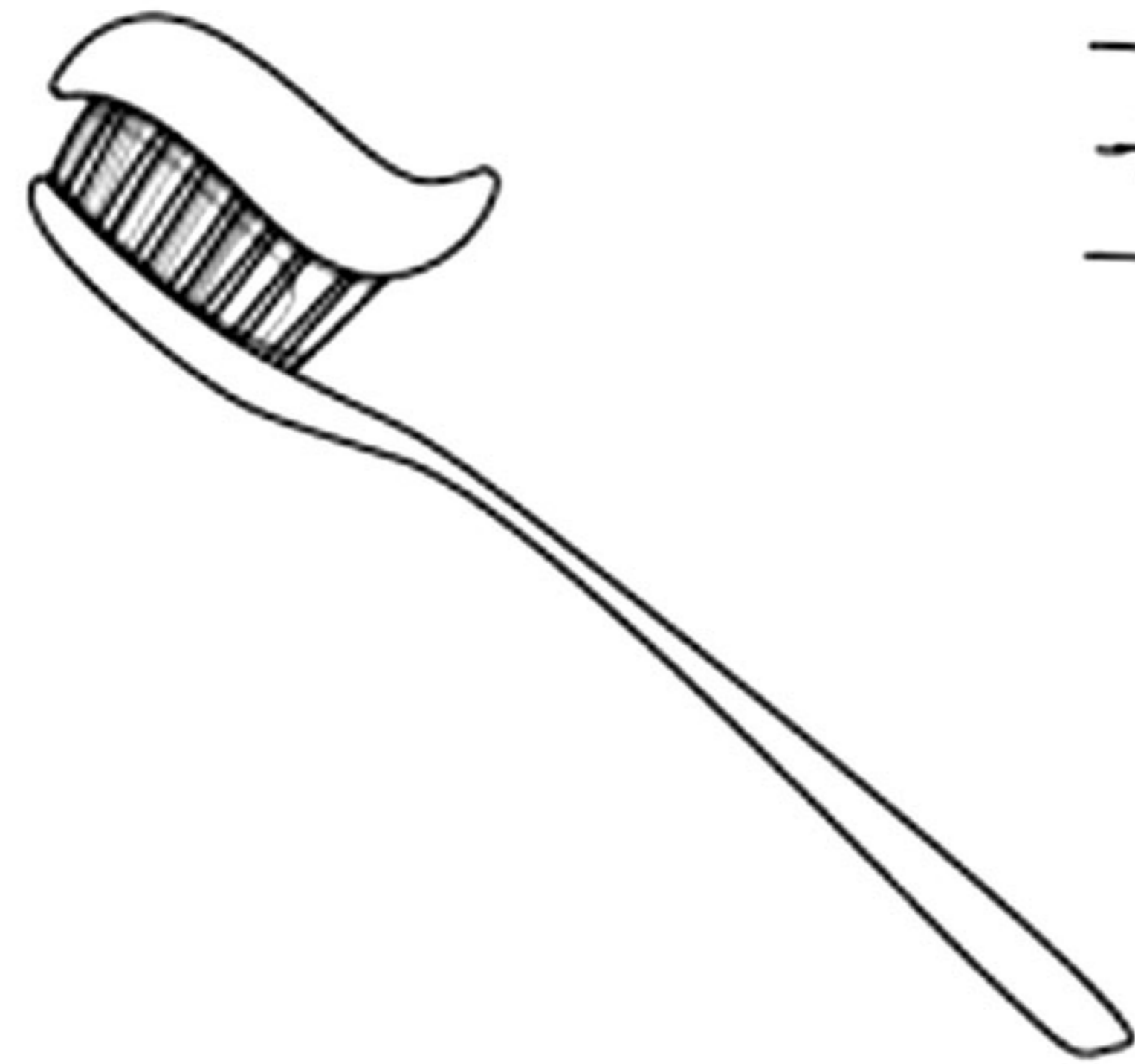



Completa el laberinto para que Papá Noel llegue a su gorro.

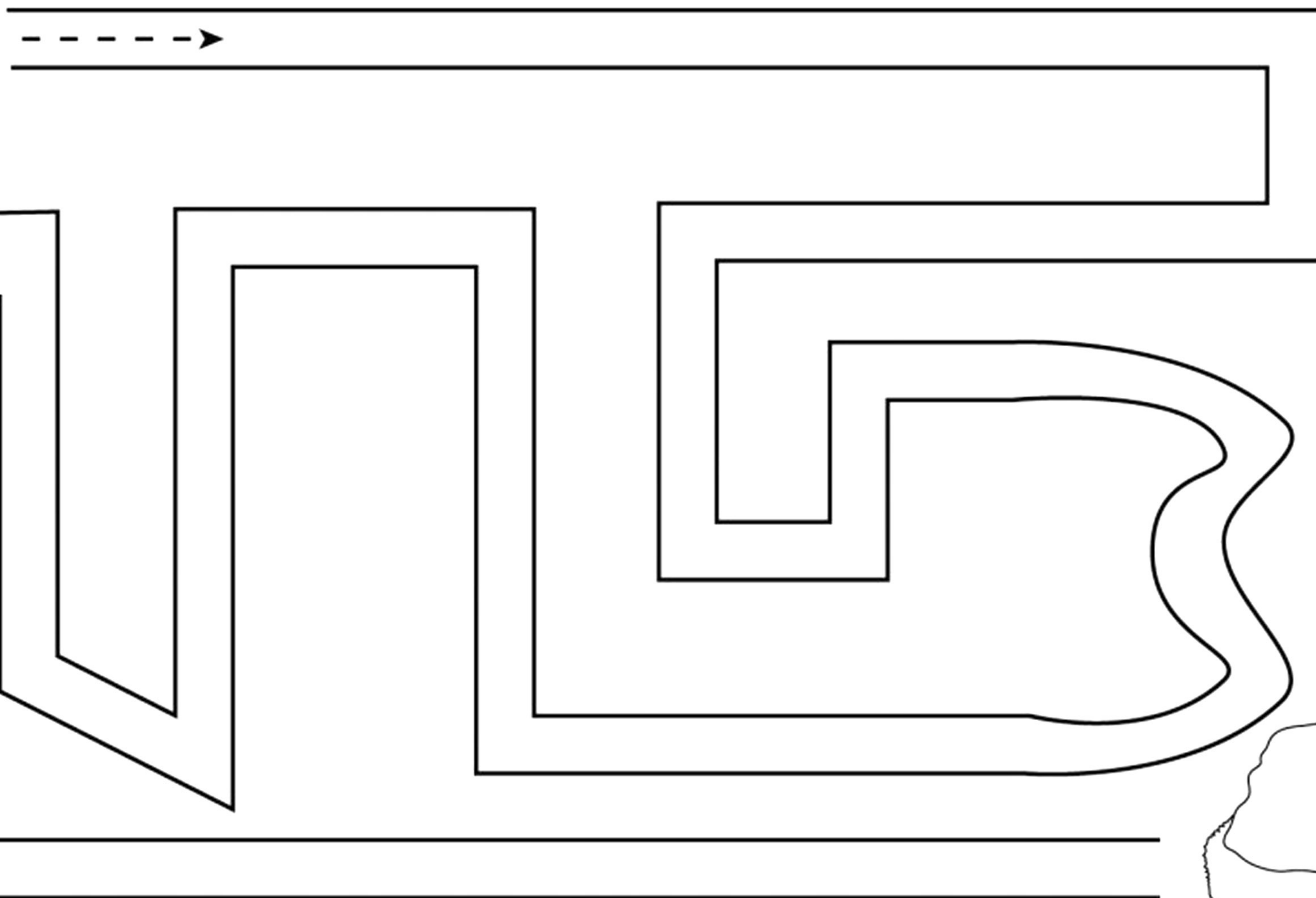



Repasa las líneas de puntos para terminar de dibujar las hélices de los aviones.

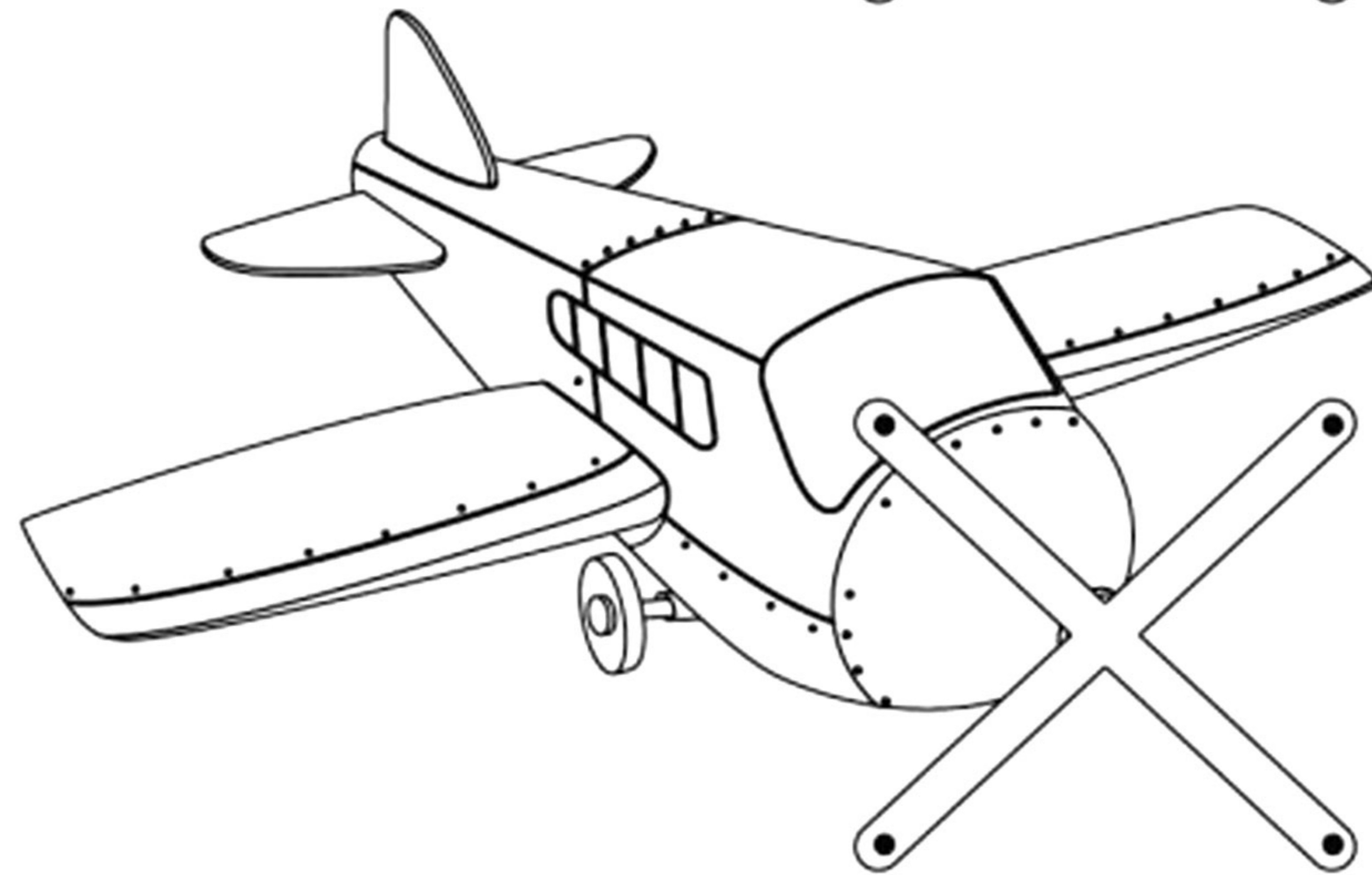
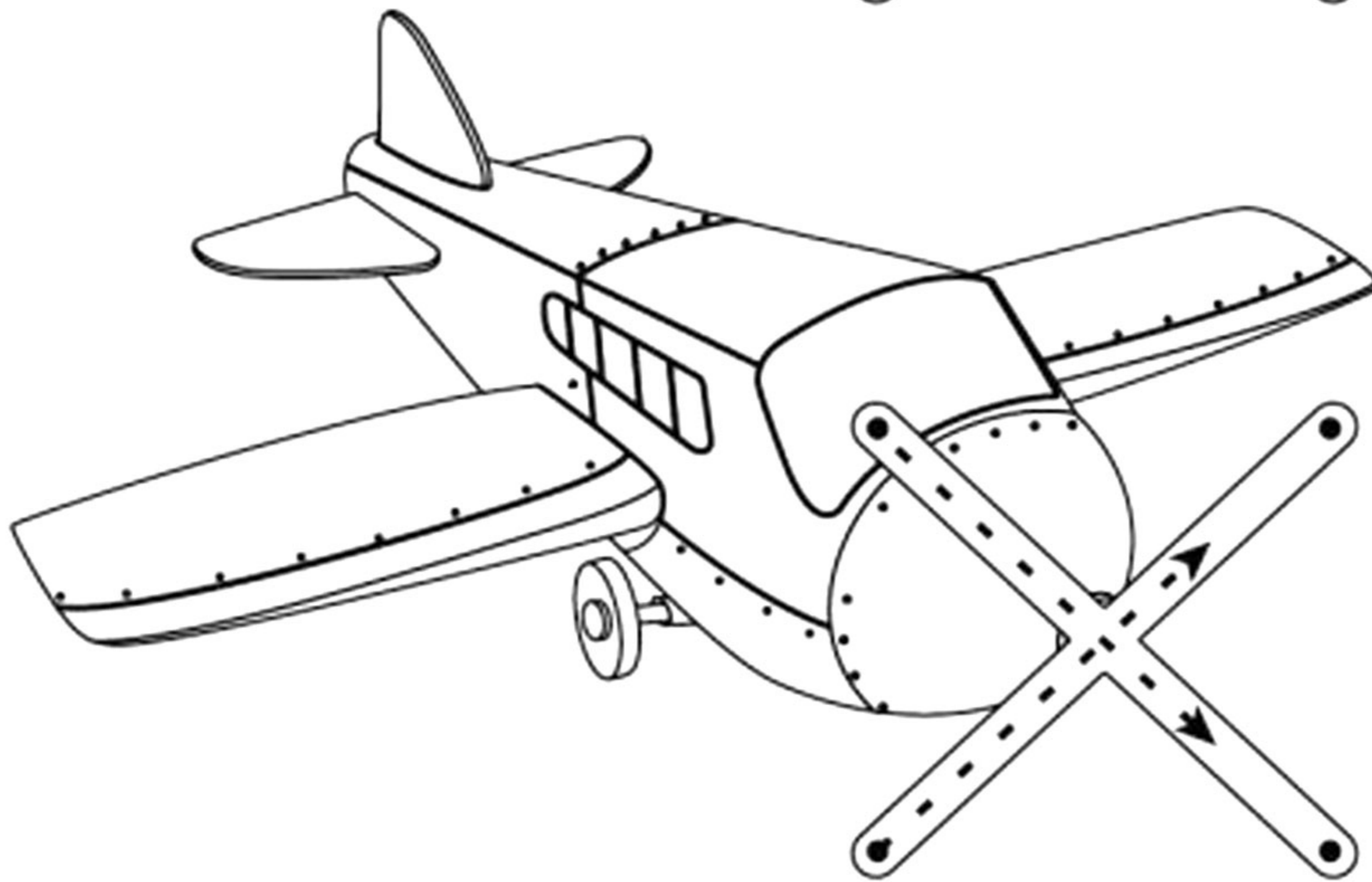
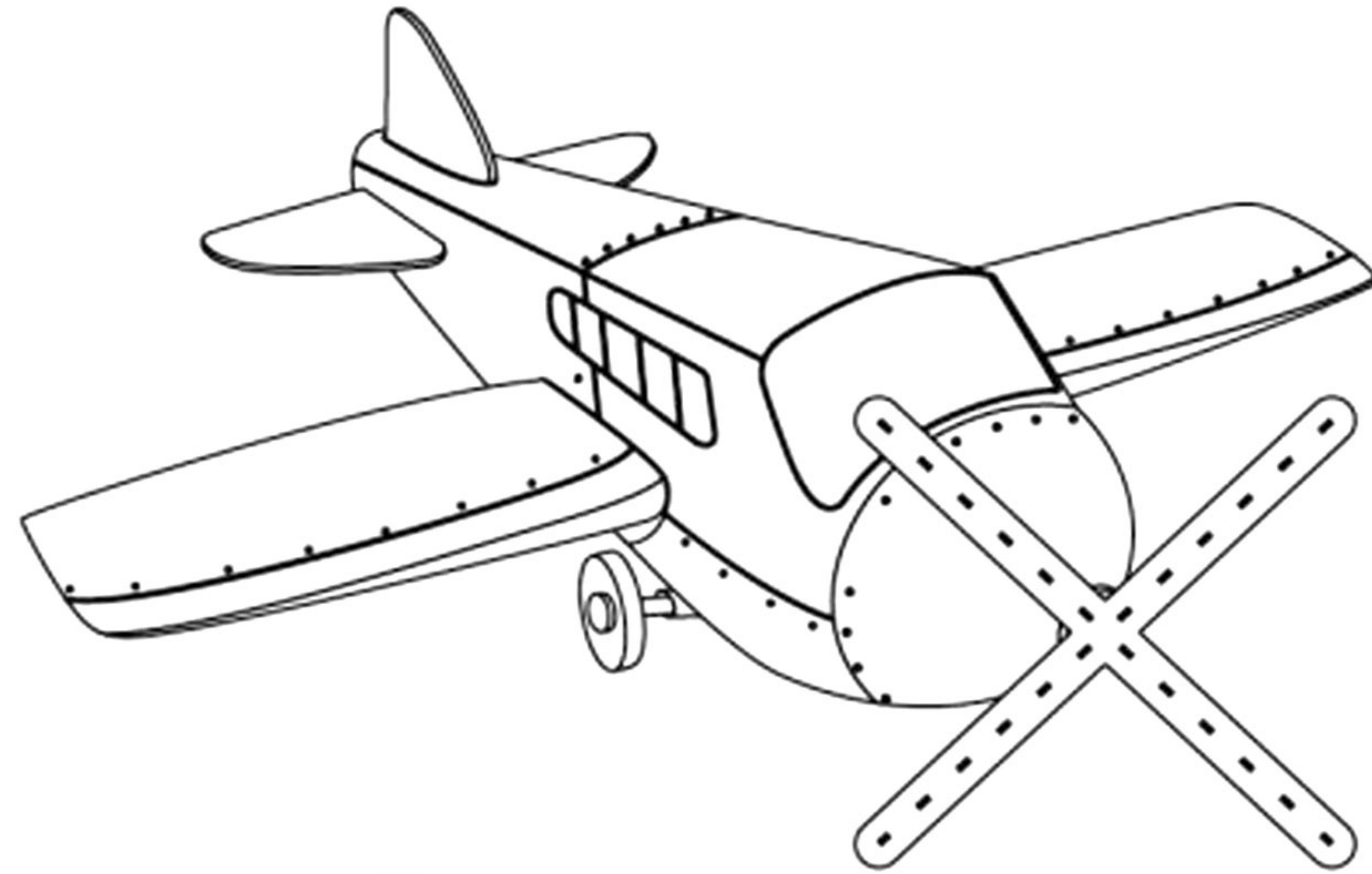
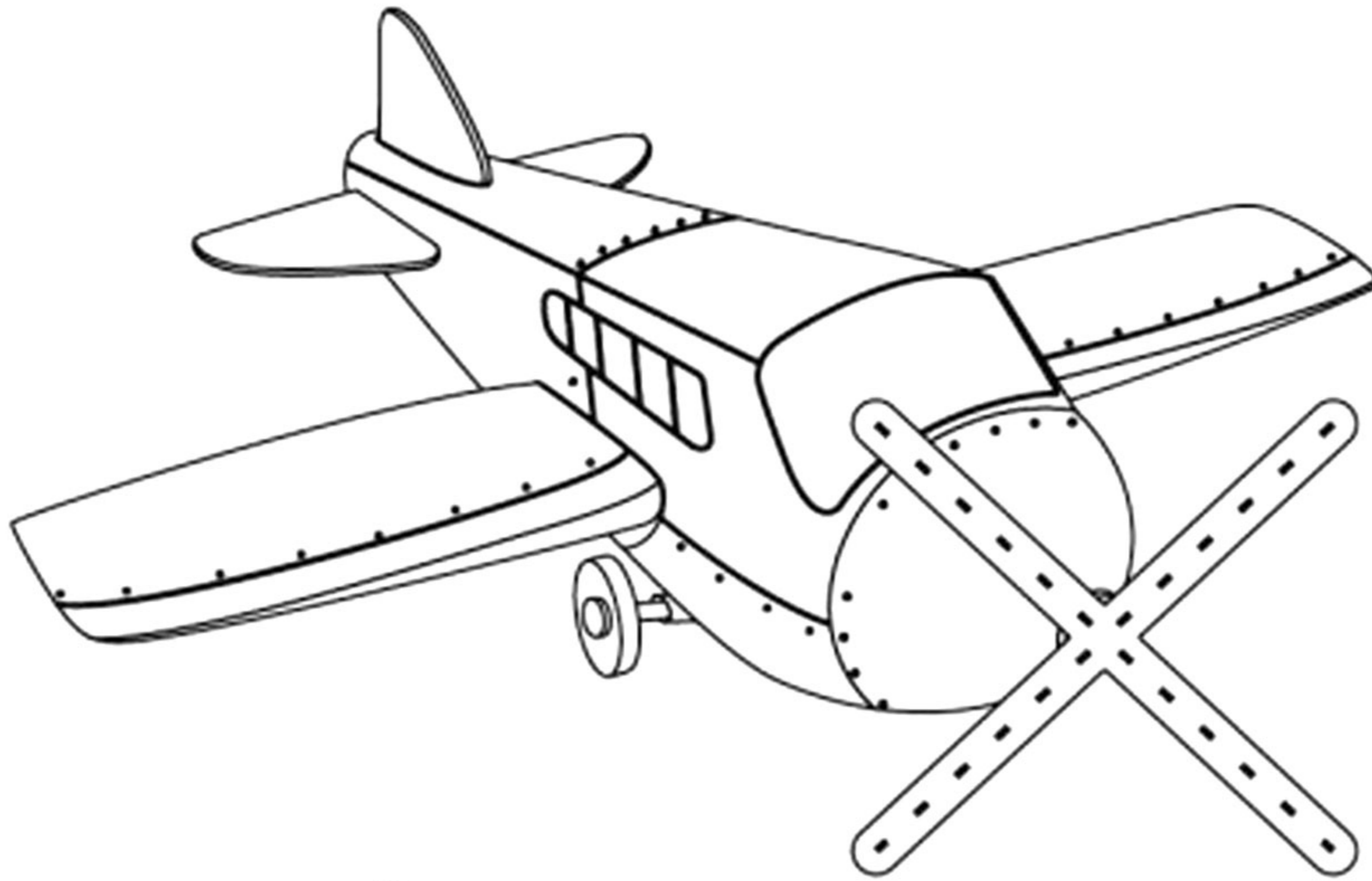



Repasa las líneas de puntos para terminar de dibujar las coronas.

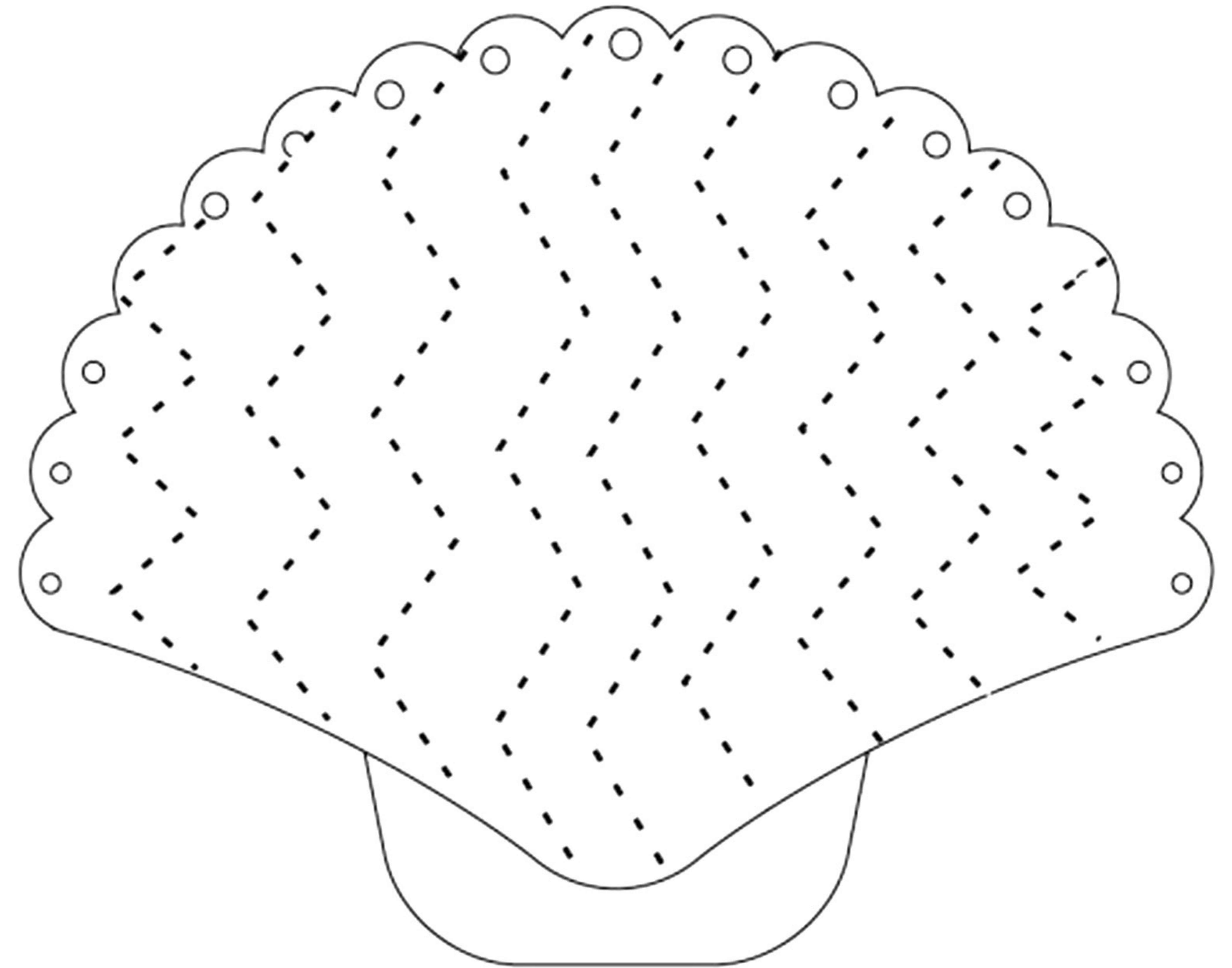
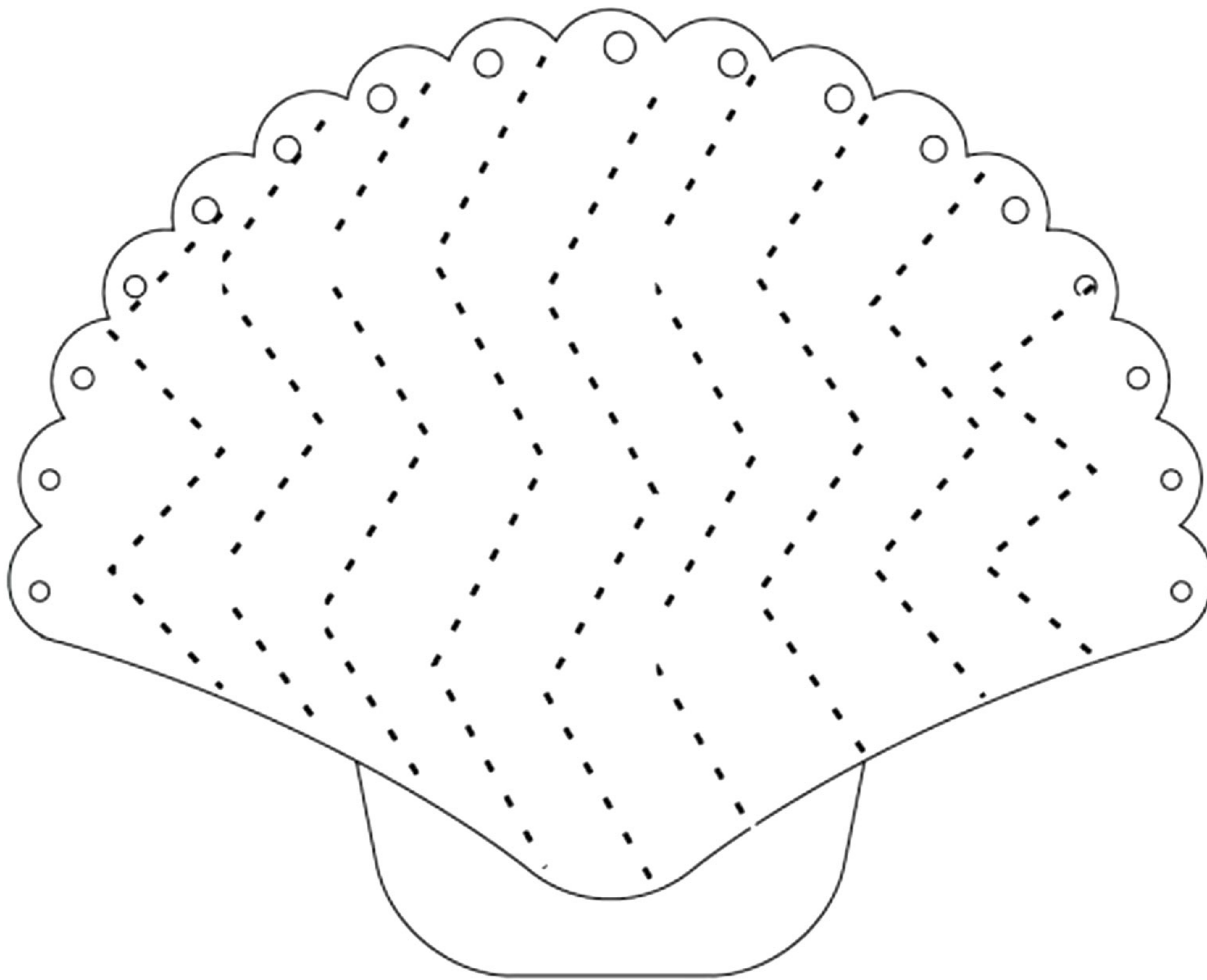



Repasa las líneas de puntos para terminar de dibujar las burbujas del pez.

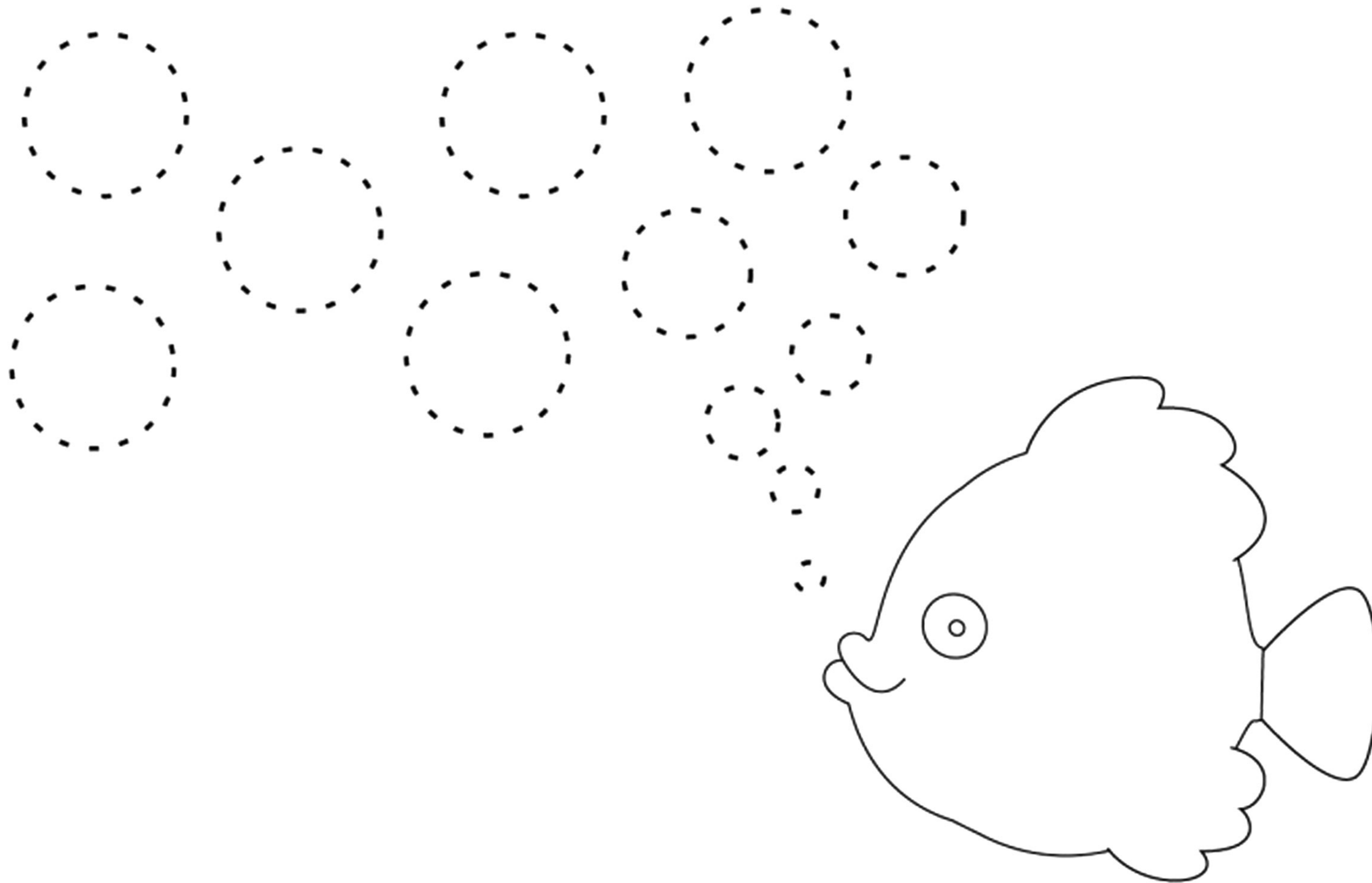



Repasa las líneas de puntos para terminar de dibujar los alimentos.

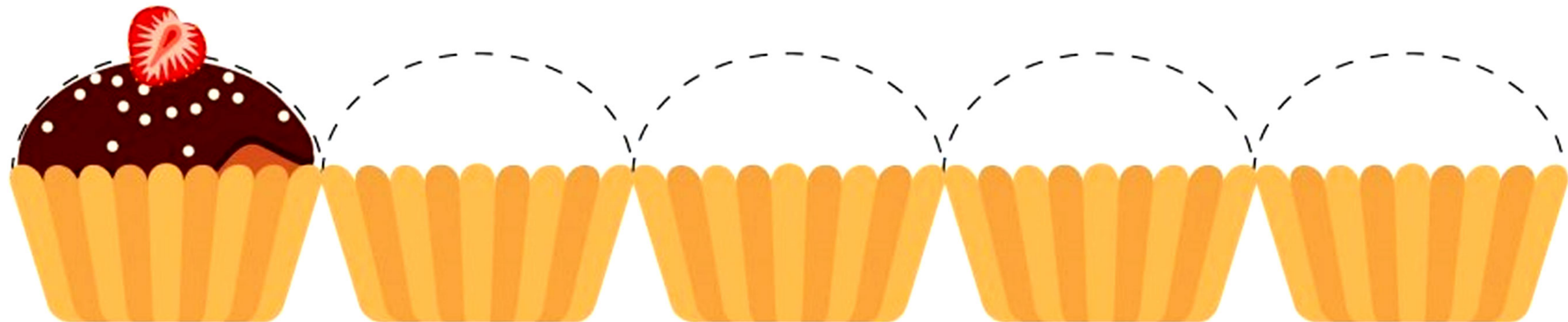
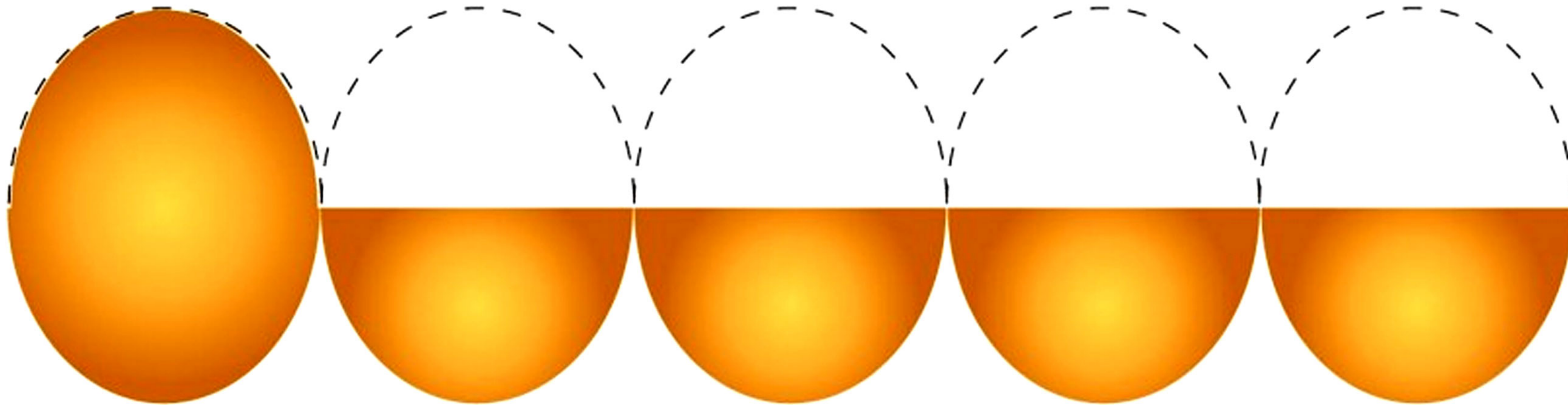



Repasa las líneas de puntos para terminar de dibujar los objetos.

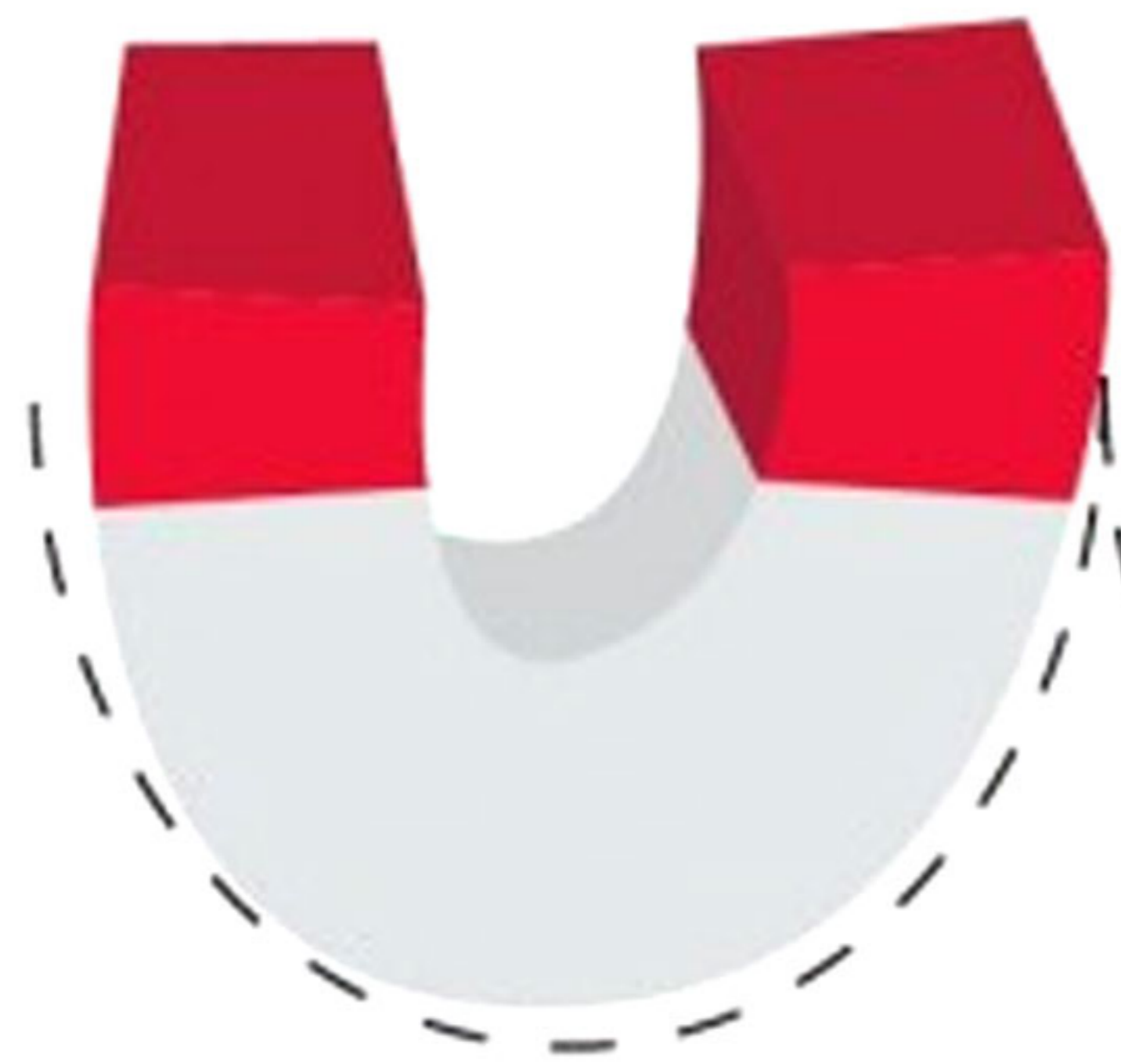



Repasa las líneas de puntos y completa la ropa de estos niños.





Repasa las líneas de puntos y completa el cuerpo de estos insectos.

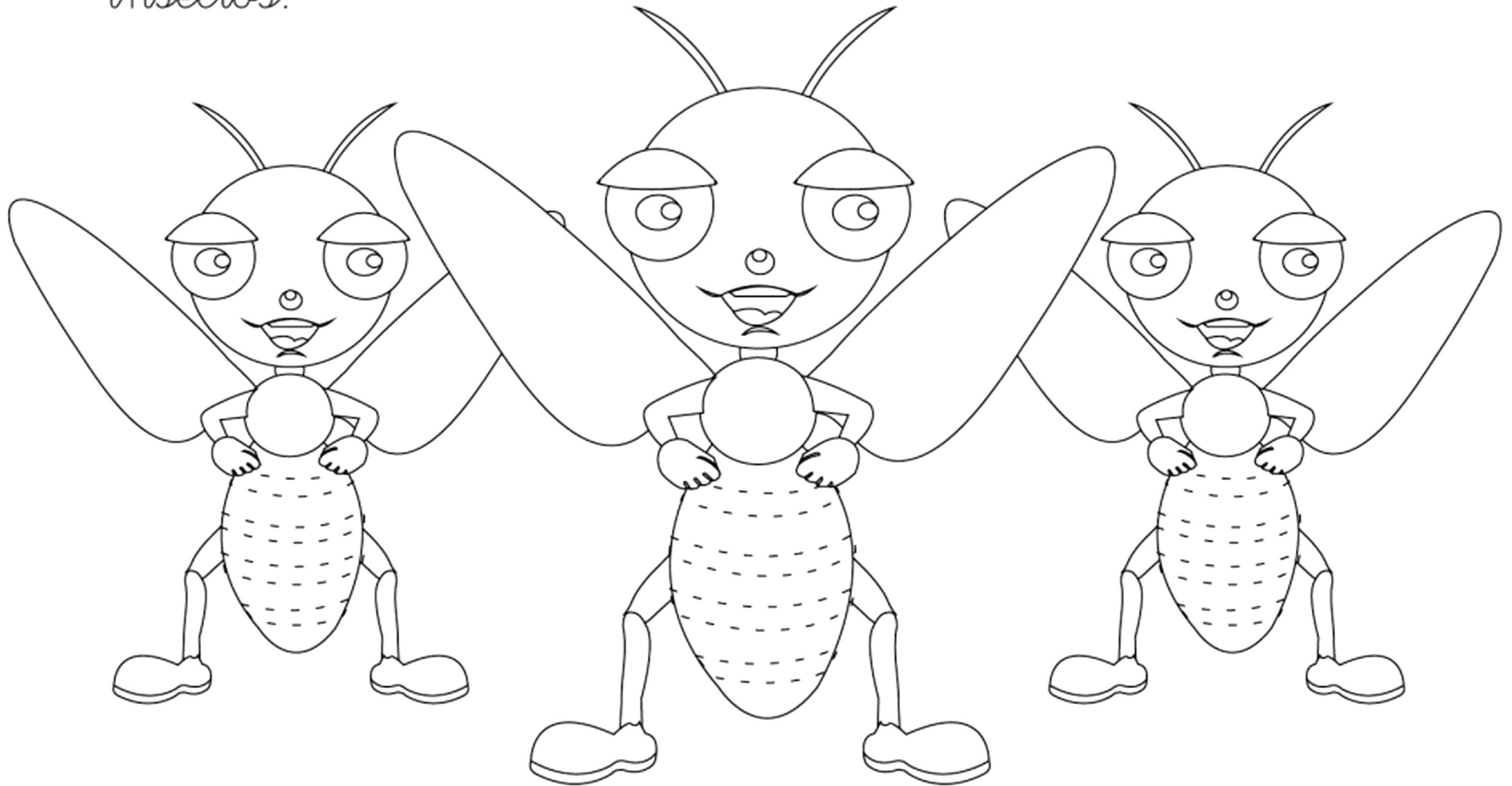



Completa los laberintos para unir los dibujos.

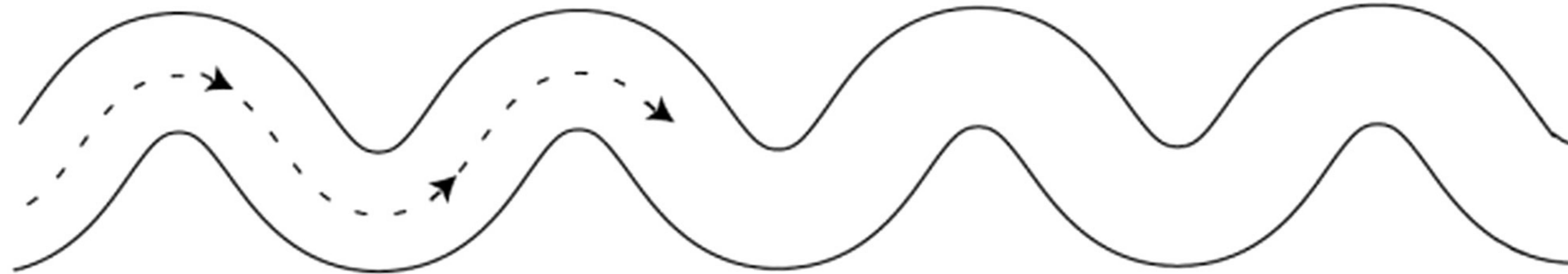
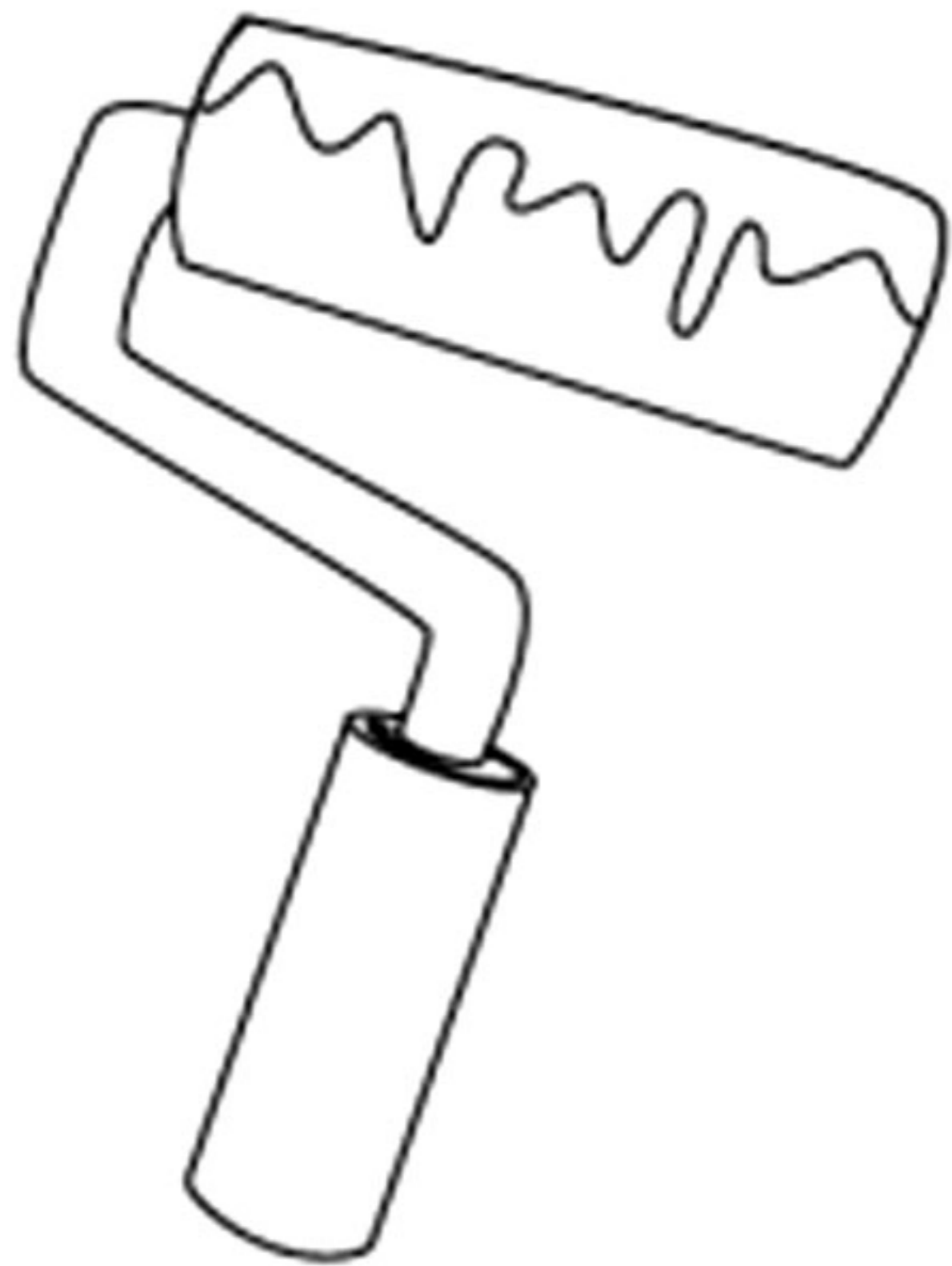



Completa el laberinto para que la mariposa llegue a las flores.

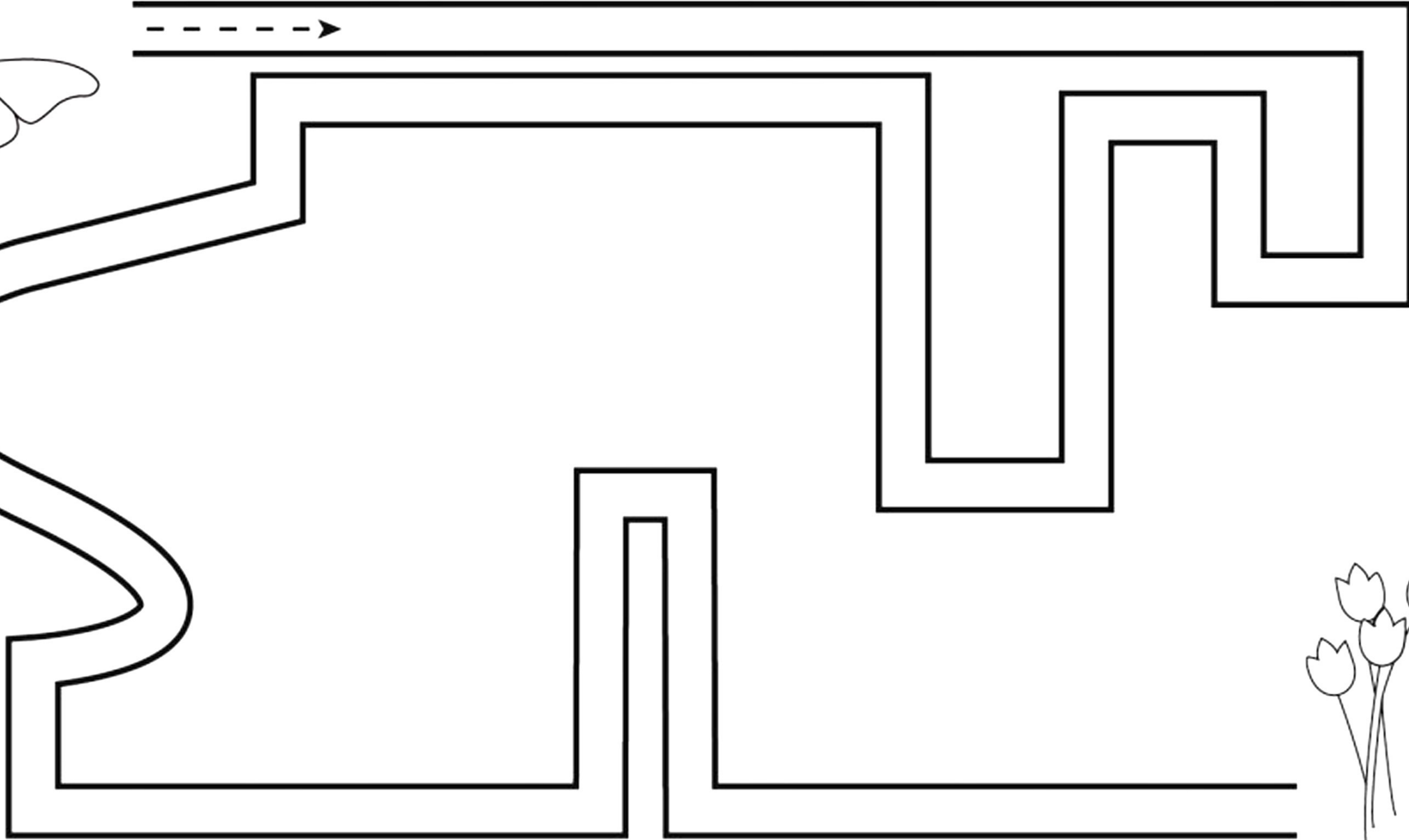
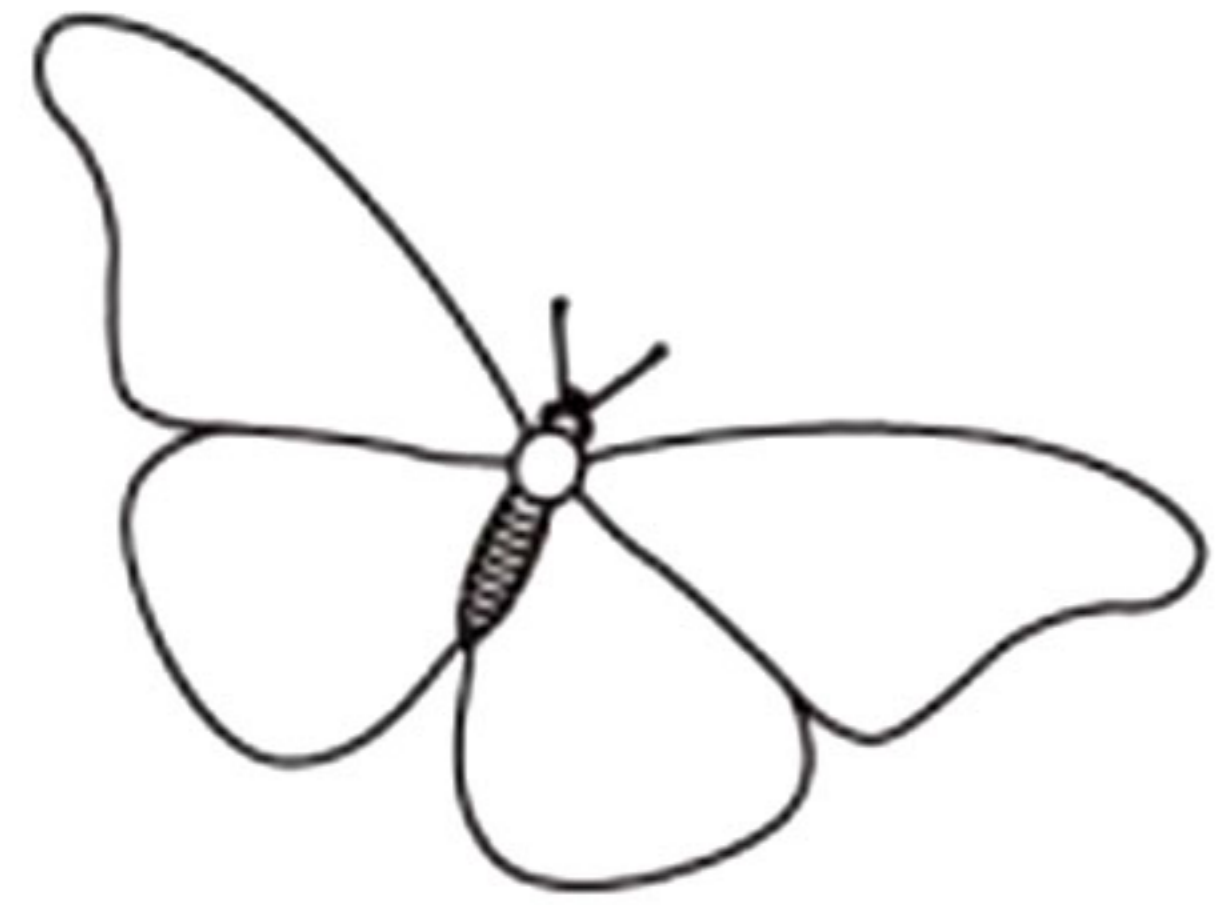



Repasa las líneas de puntos para terminar de dibujar las coronas.

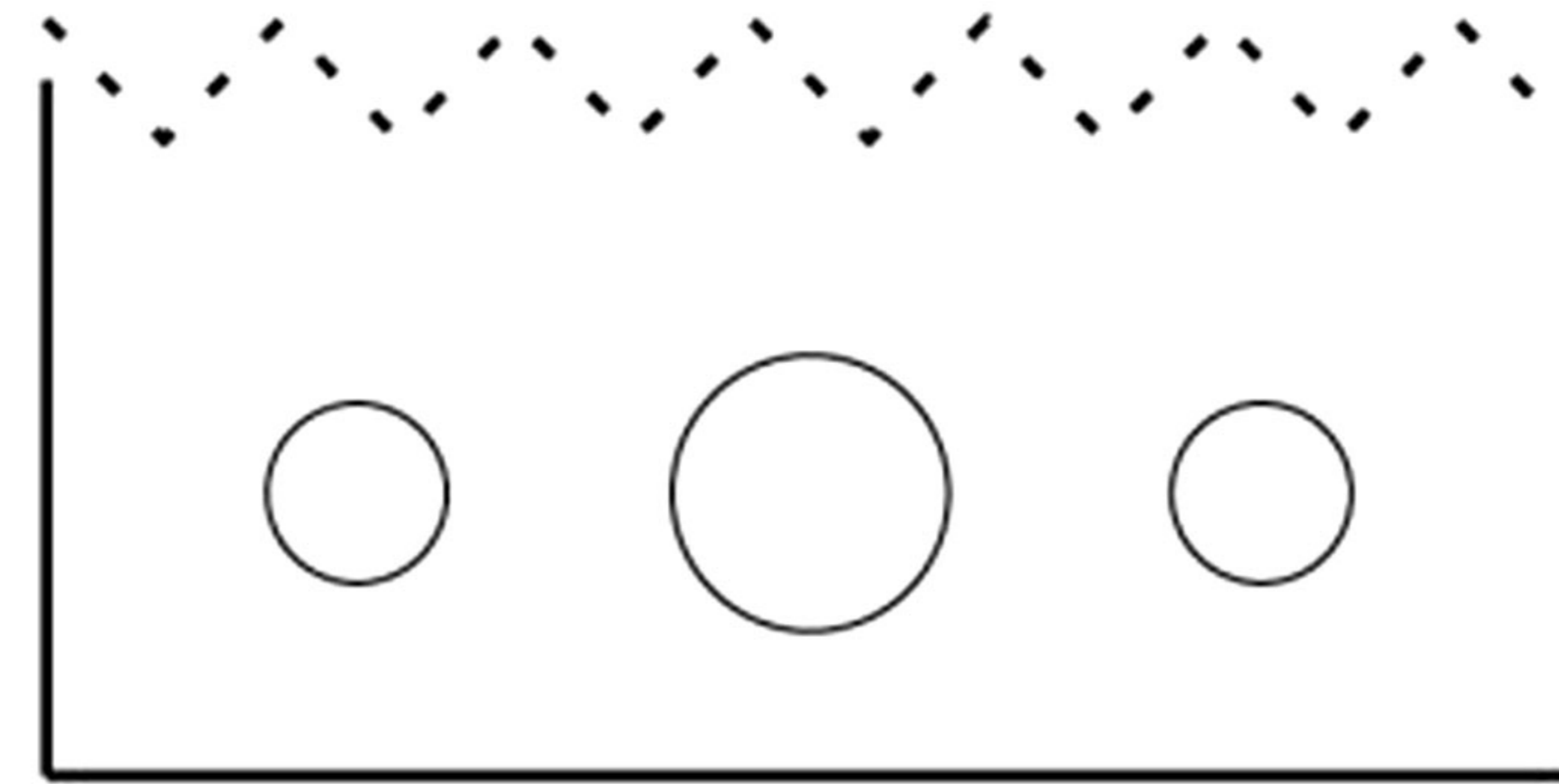
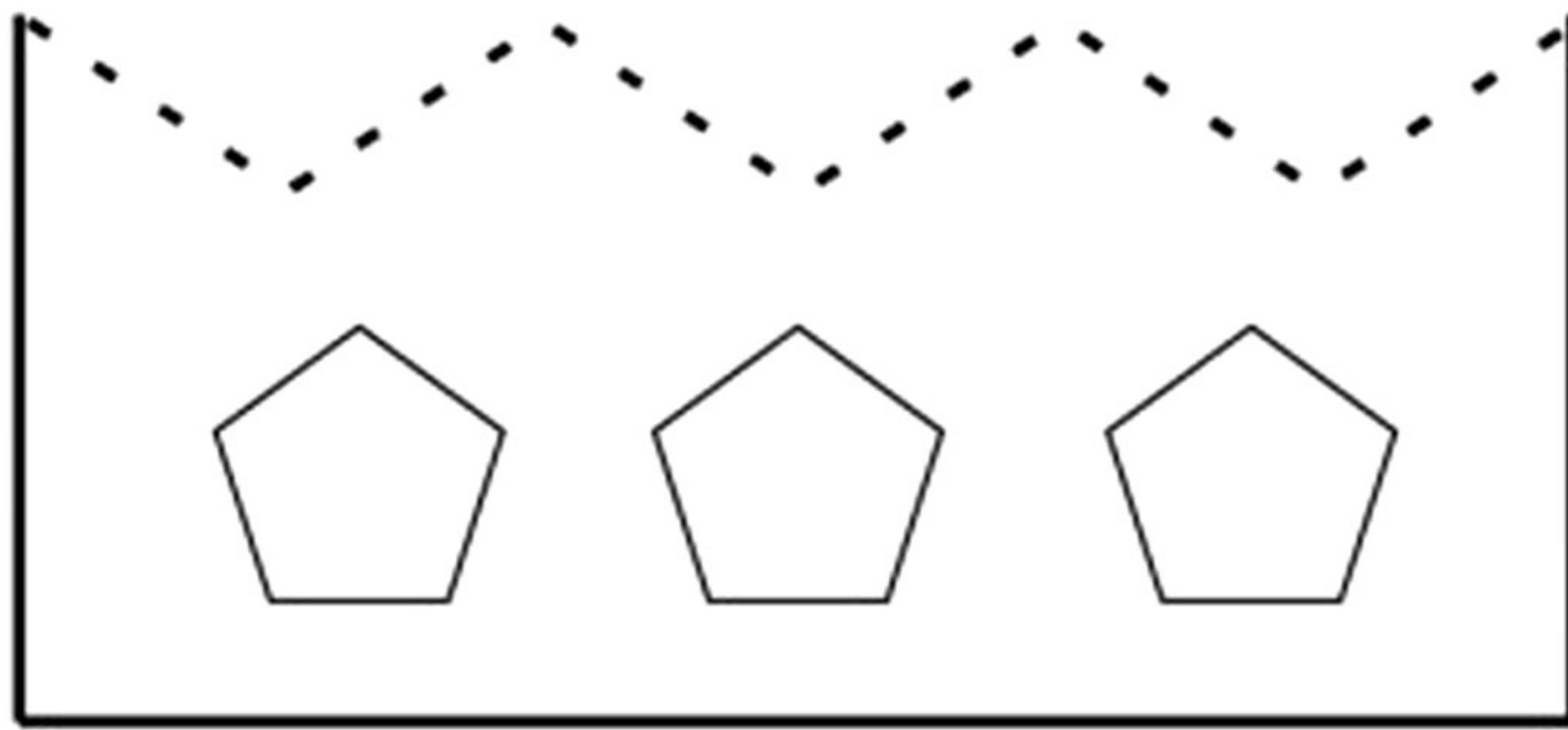



Repasa las líneas de puntos y completa la caja de  
ceras de colores.

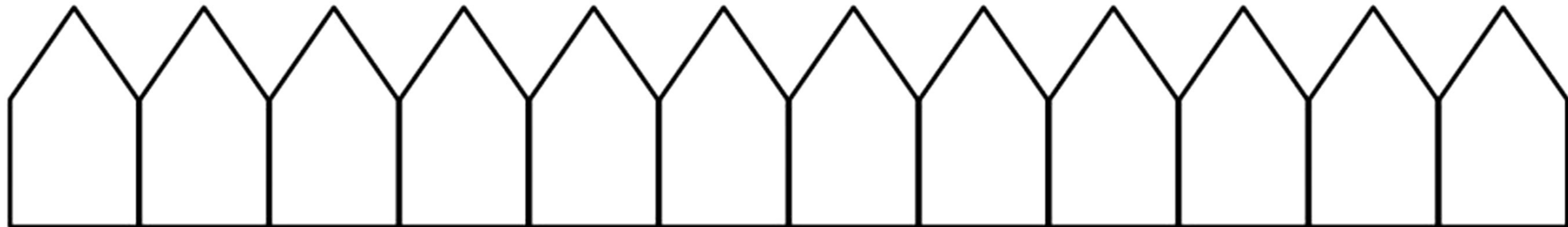

colores

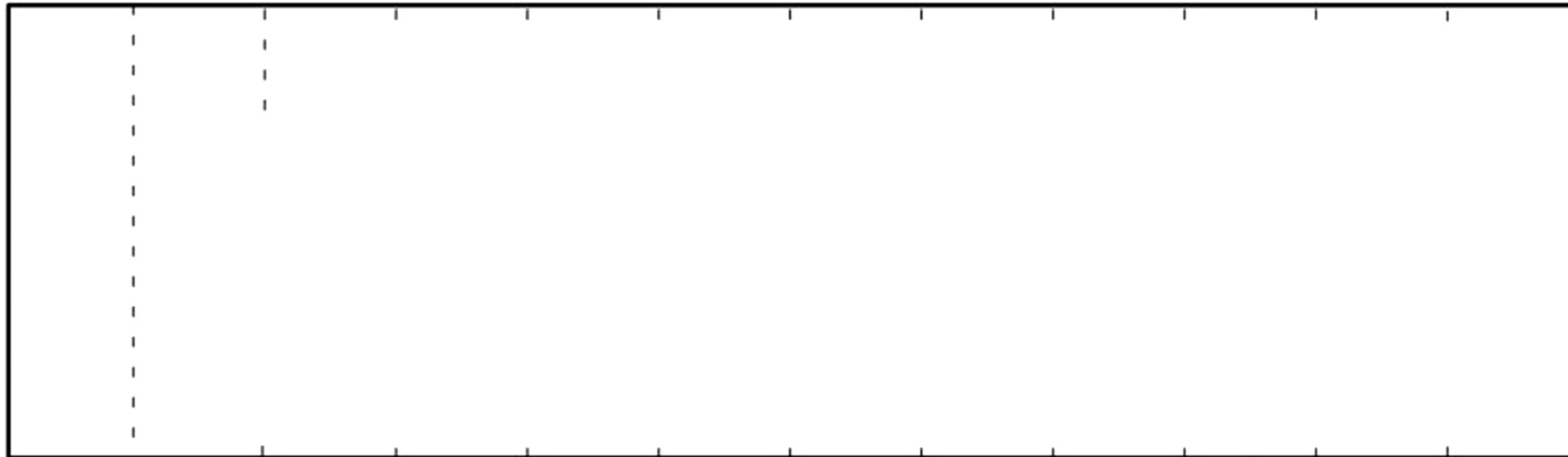



FICHAS PARA TRABAJAR LA

# **ATENCIÓN**

---





Rodea los objetos que sean iguales  
a los modelos

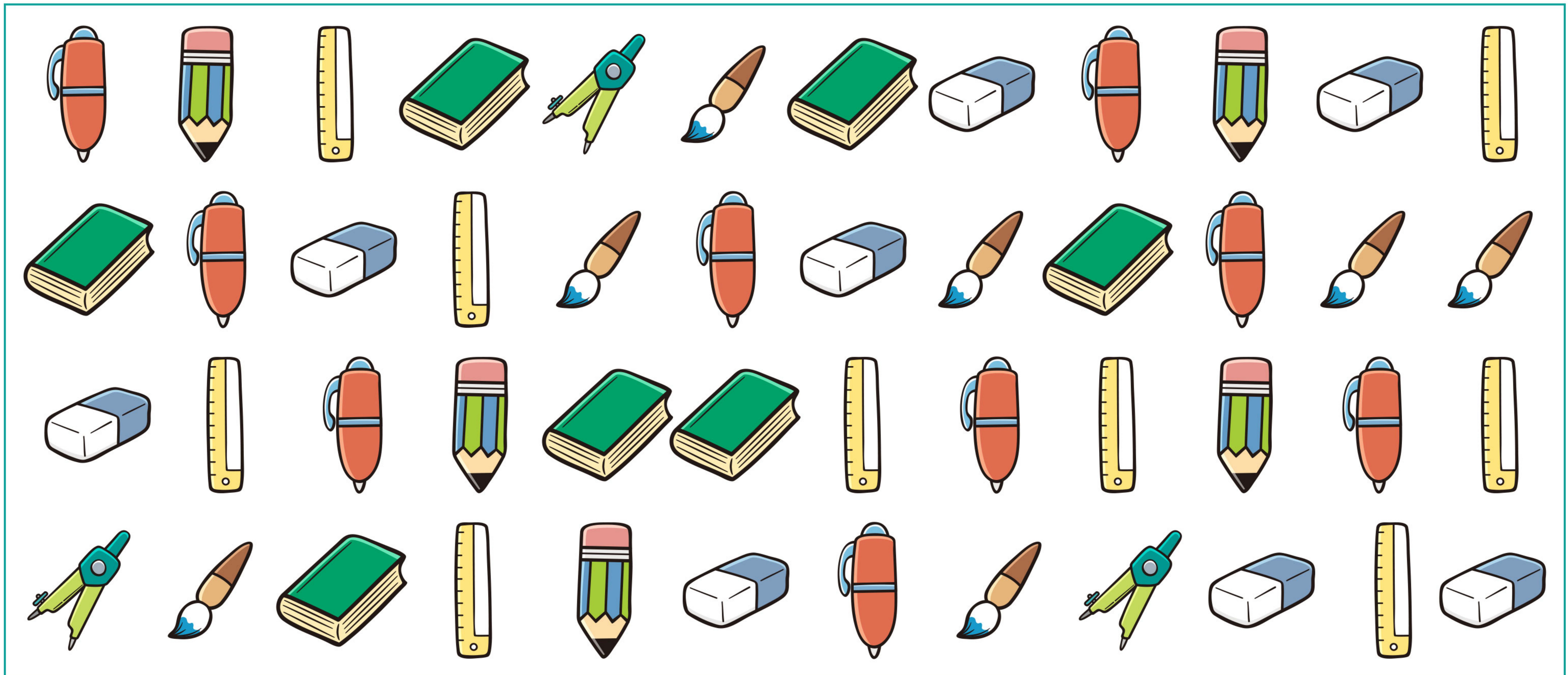



Une los objetos siguiendo el orden marcado

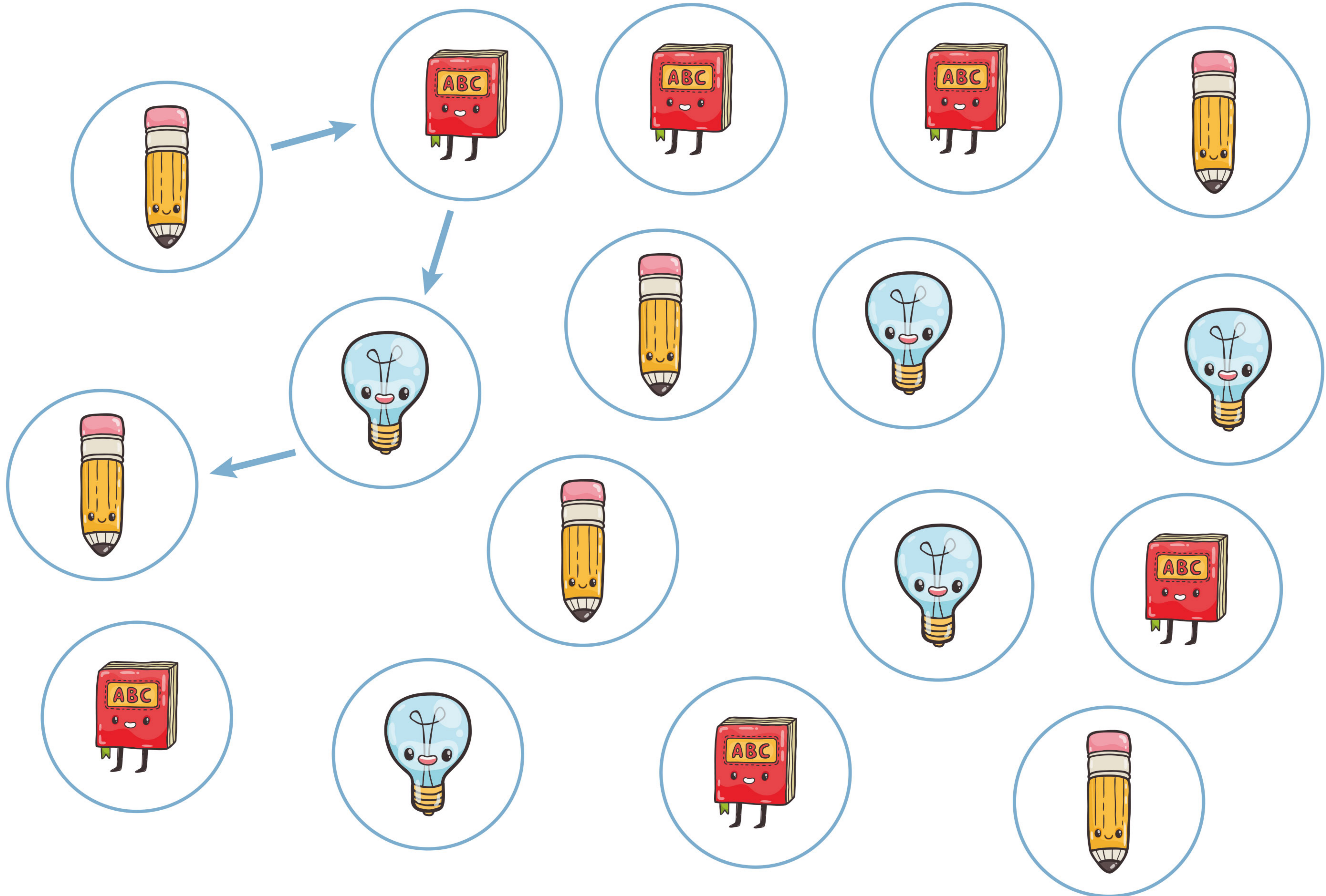



Completa los dibujos con los símbolos  
que les corresponden

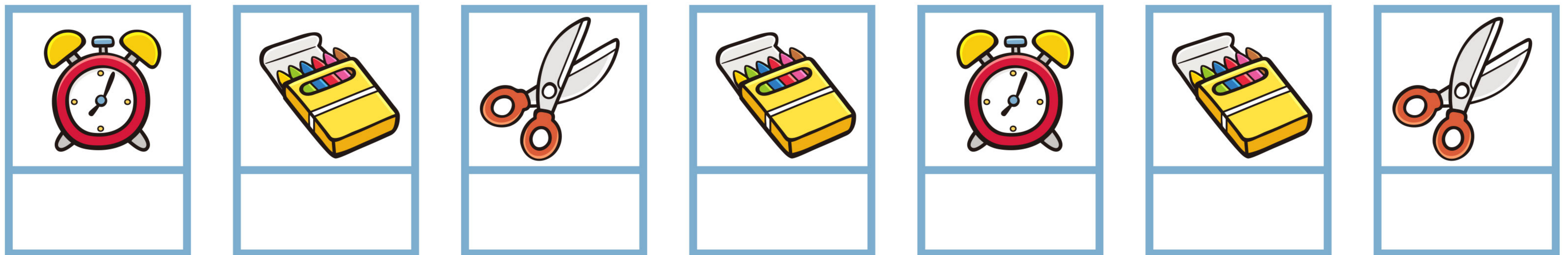
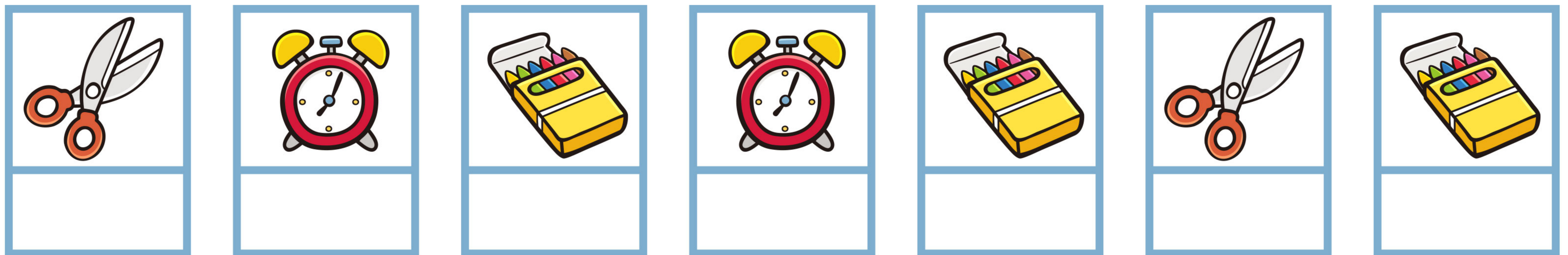
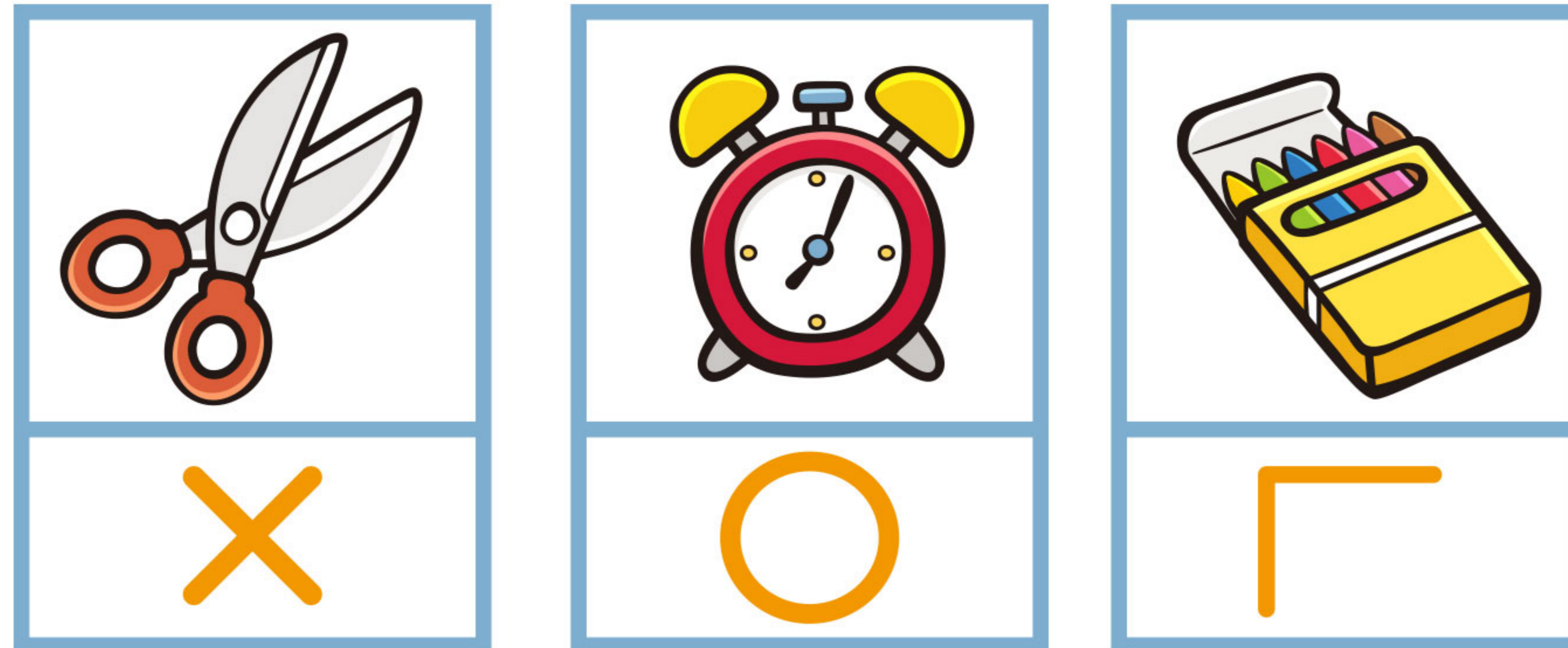



Tacha el objeto que sobra en cada fila

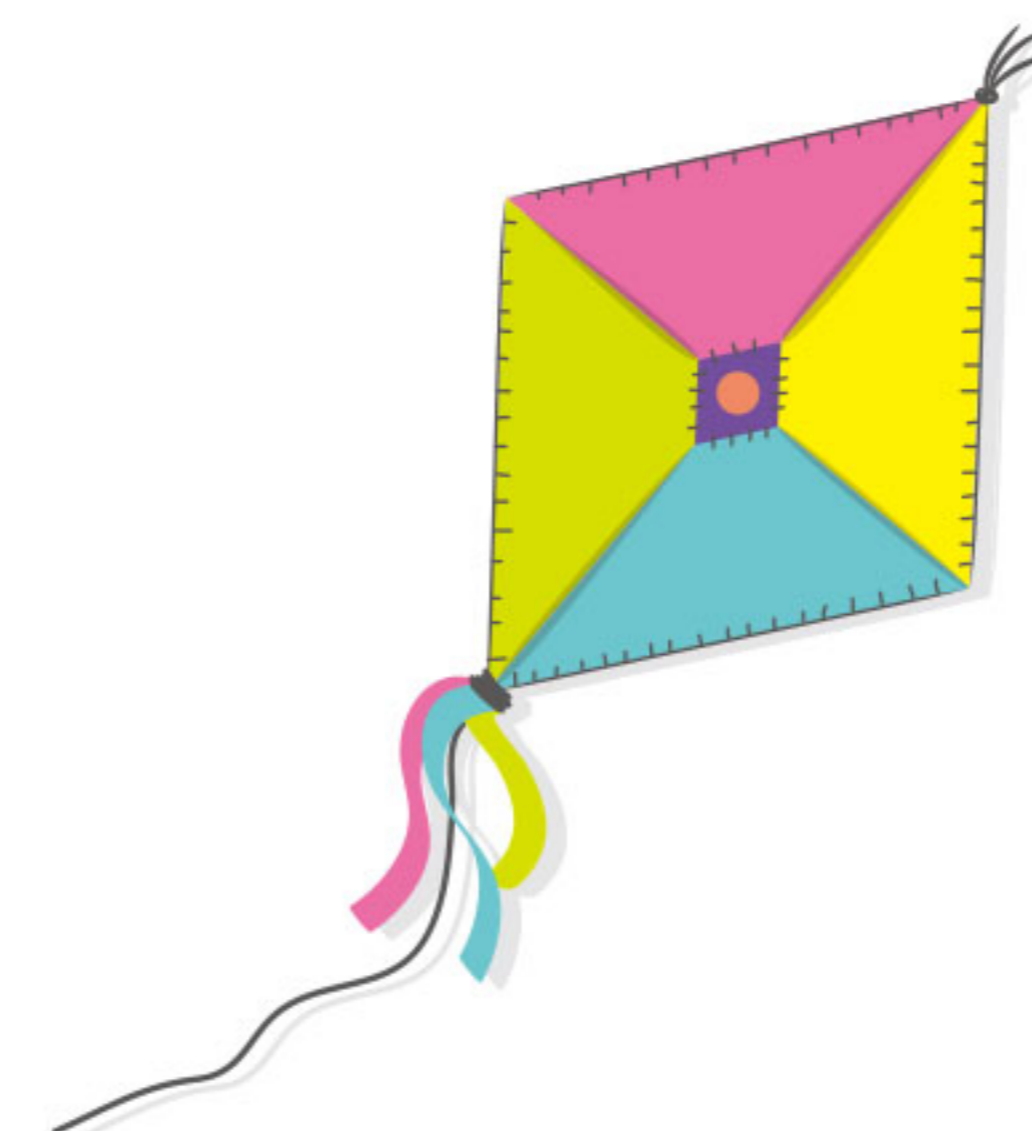
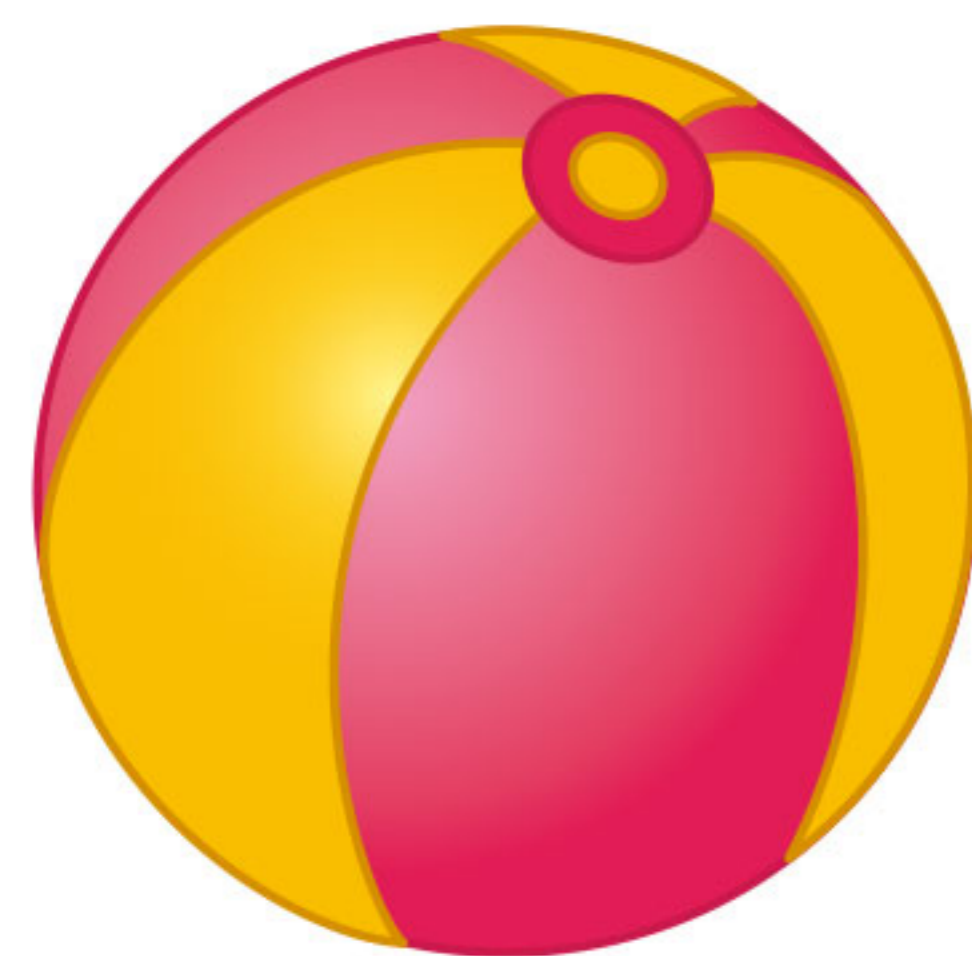
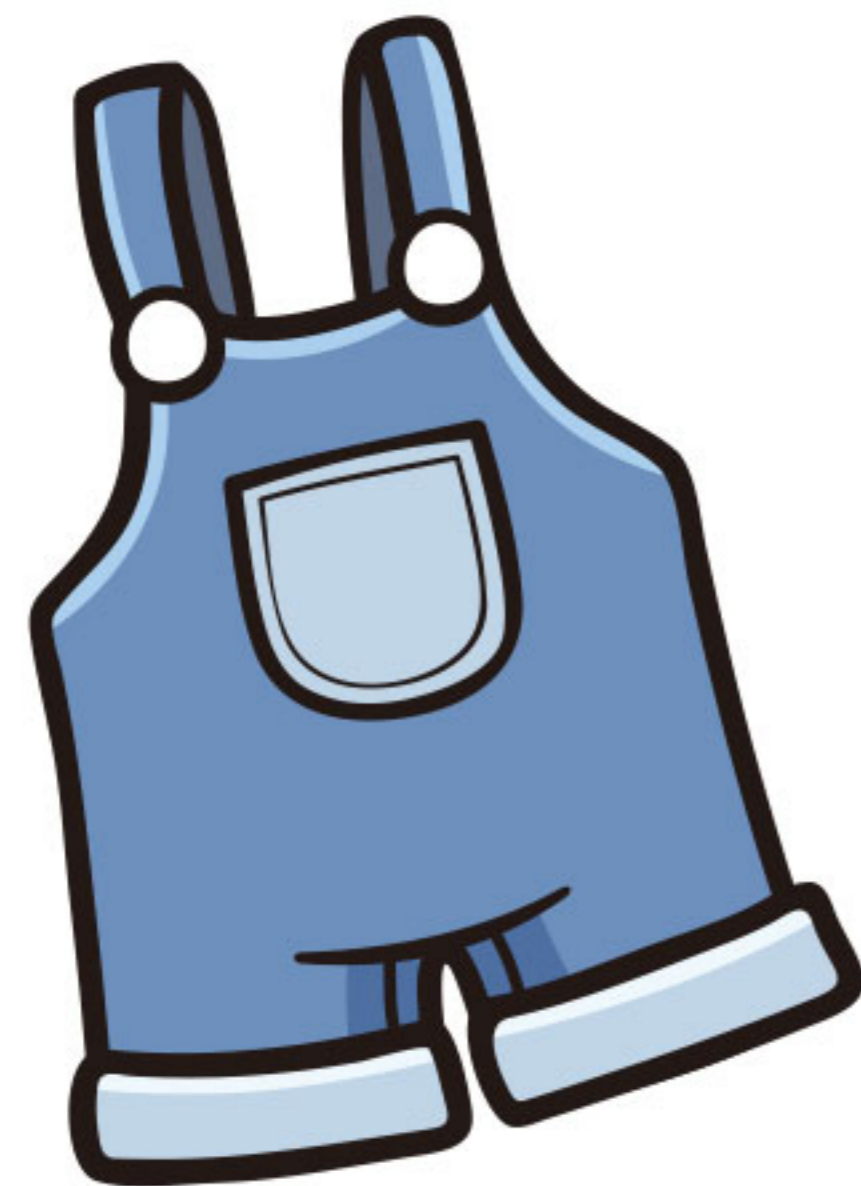



Señala el objeto que completa la serie

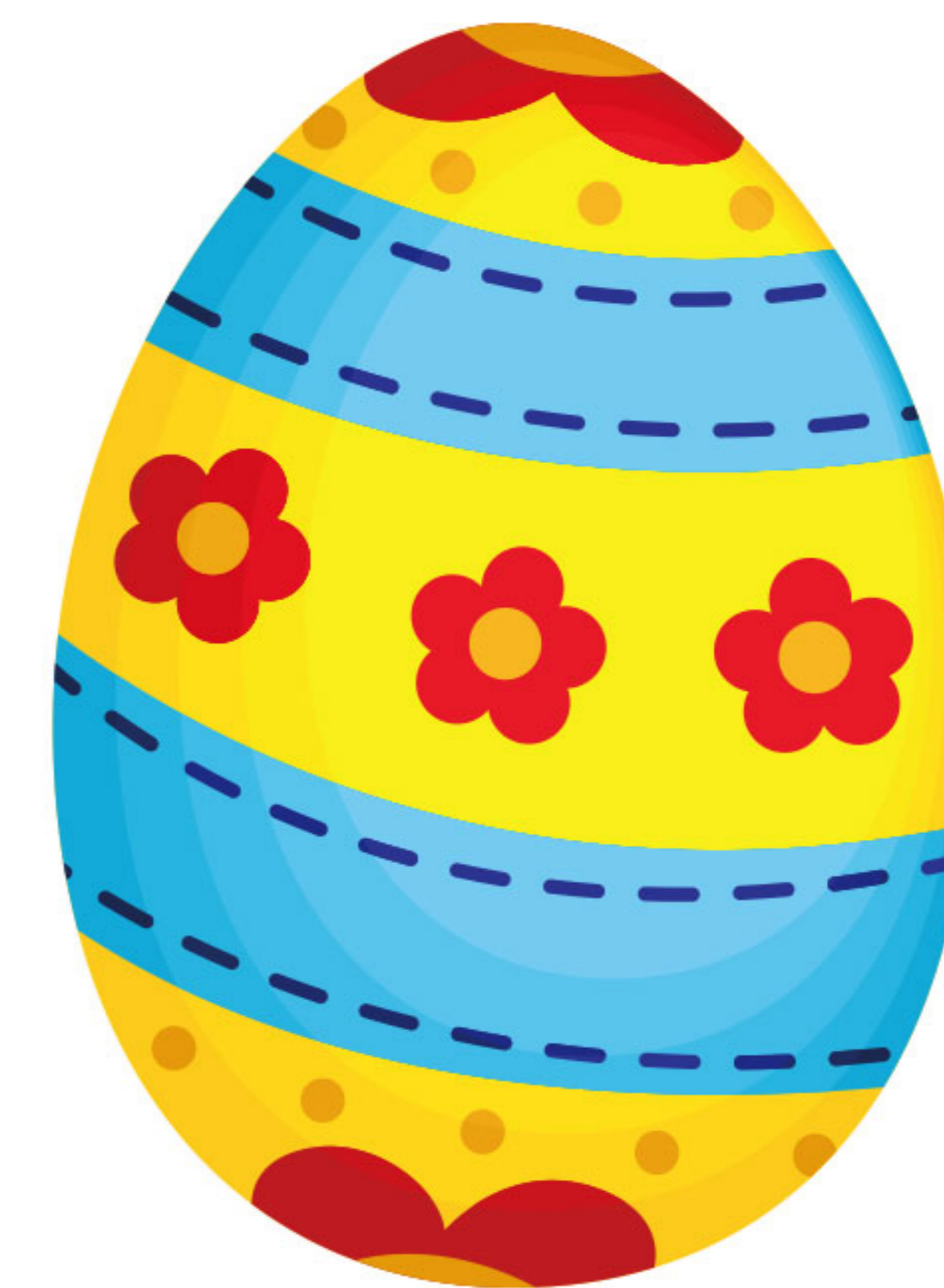
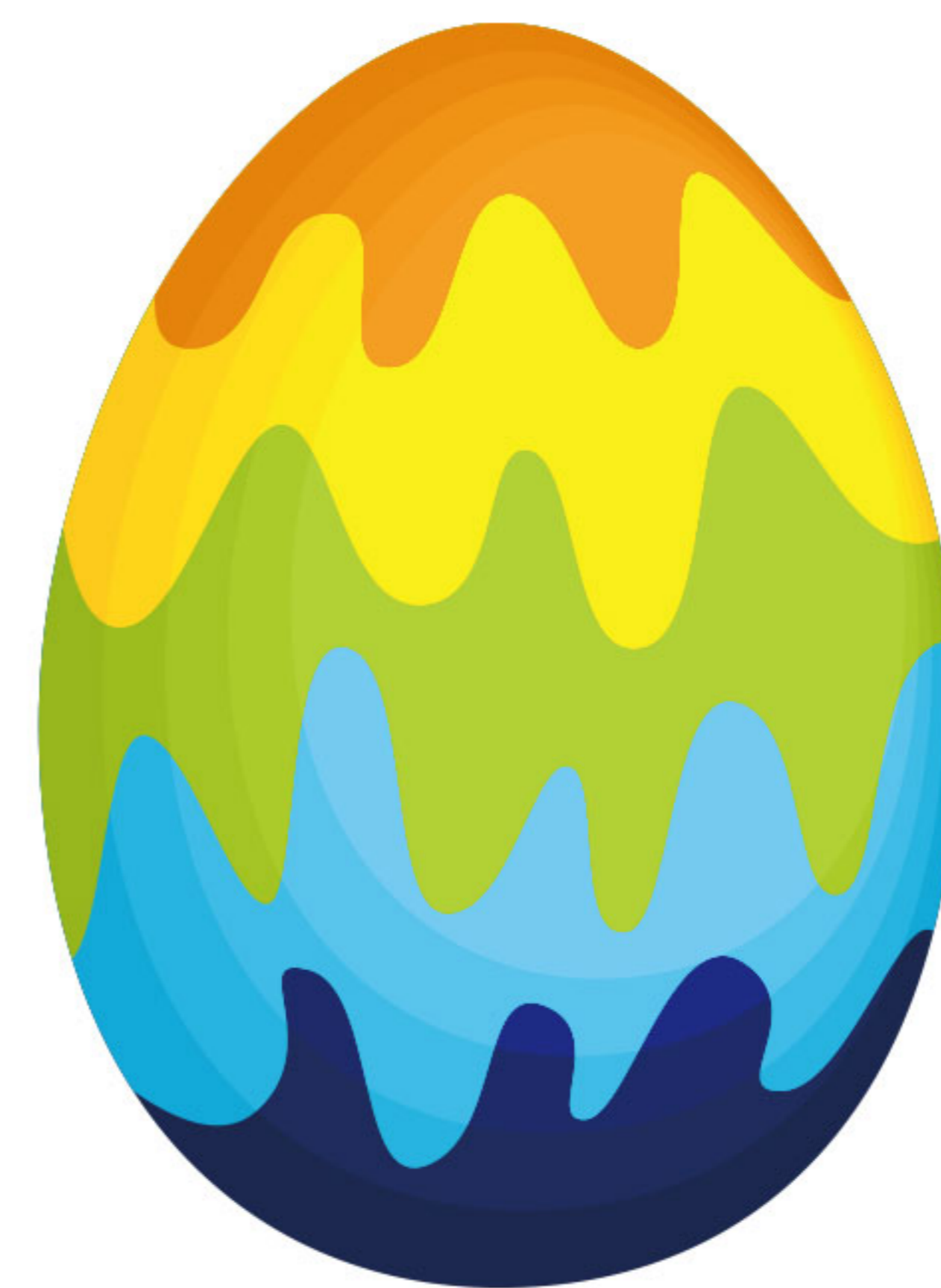
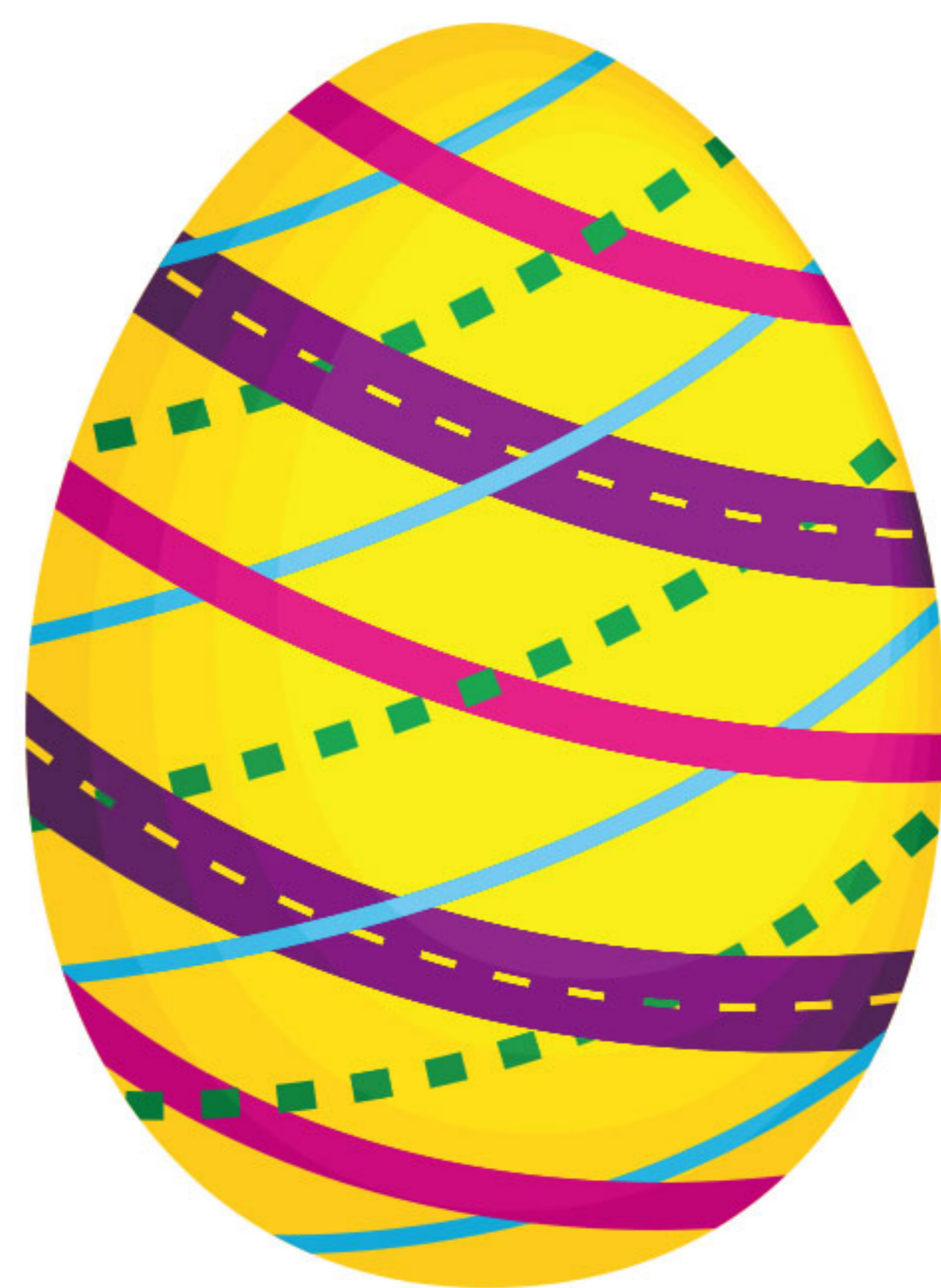
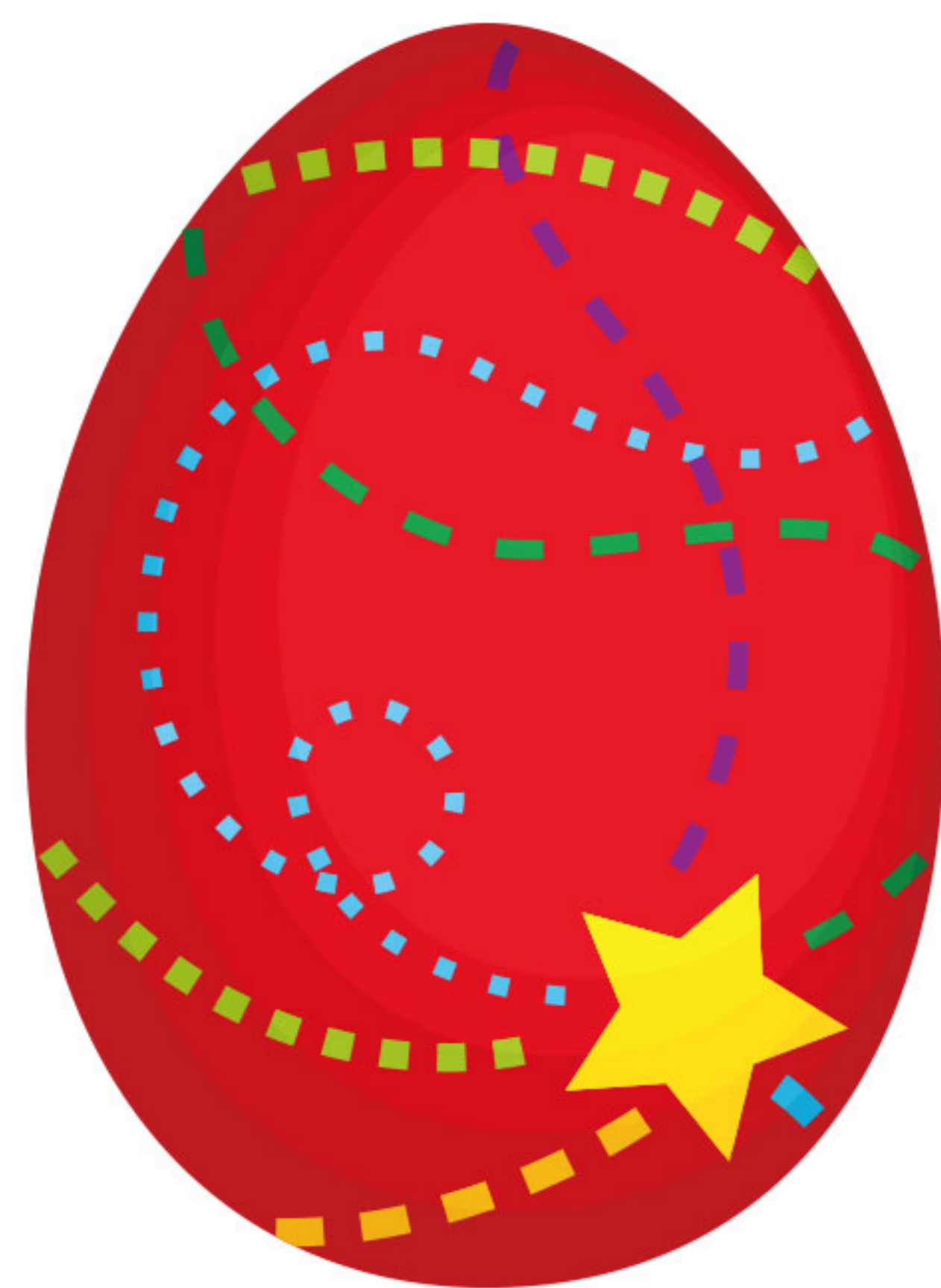
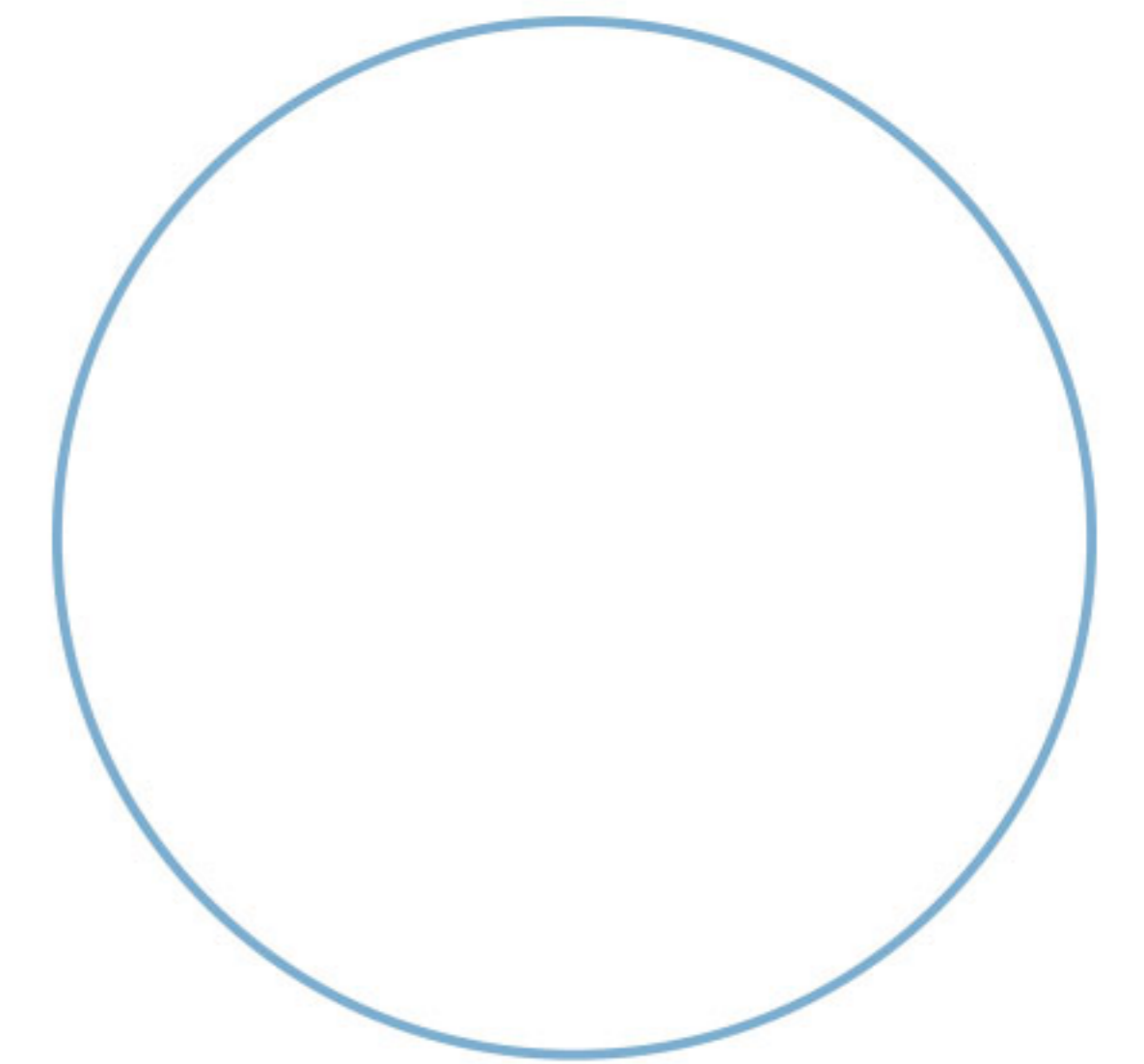
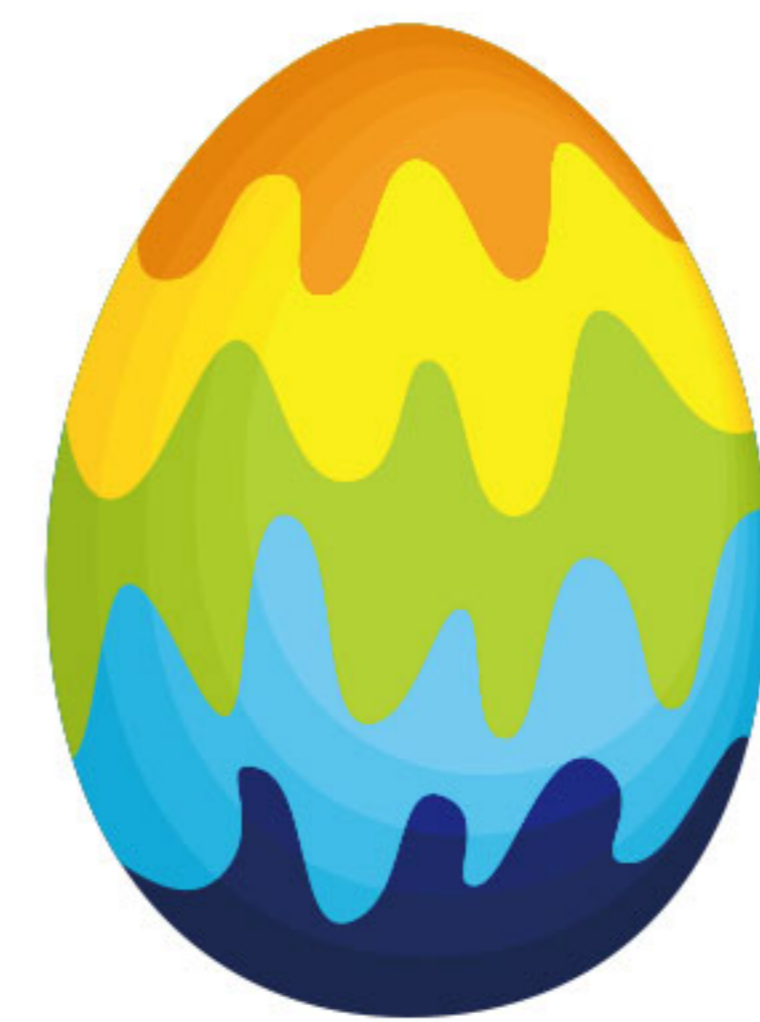
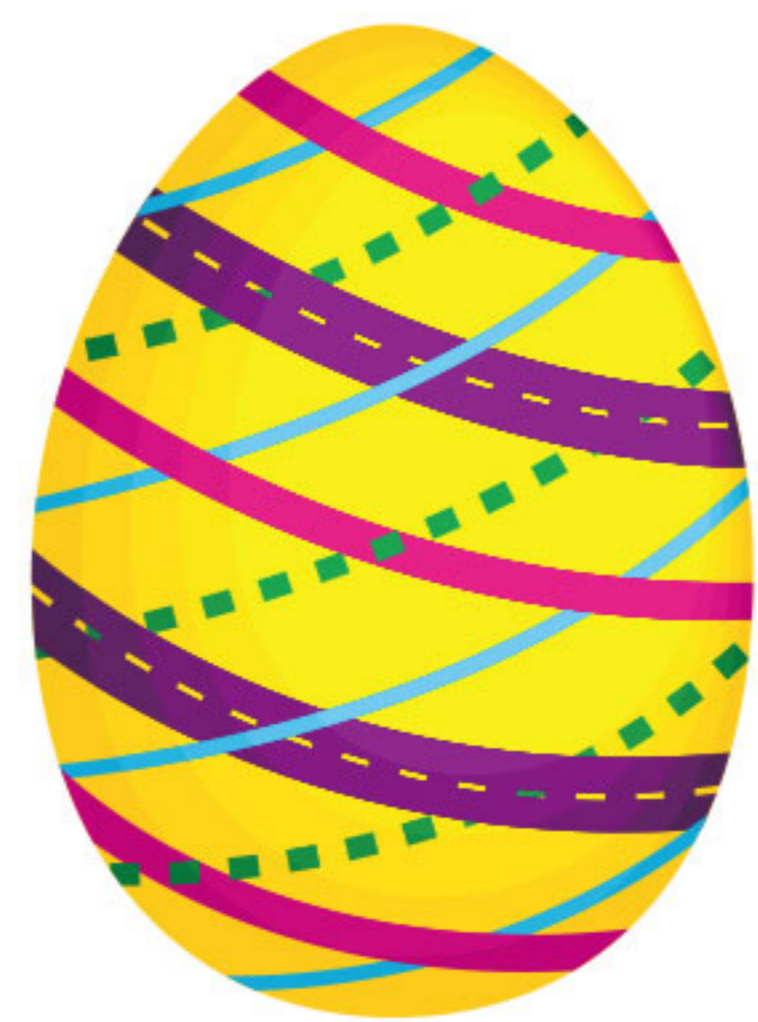
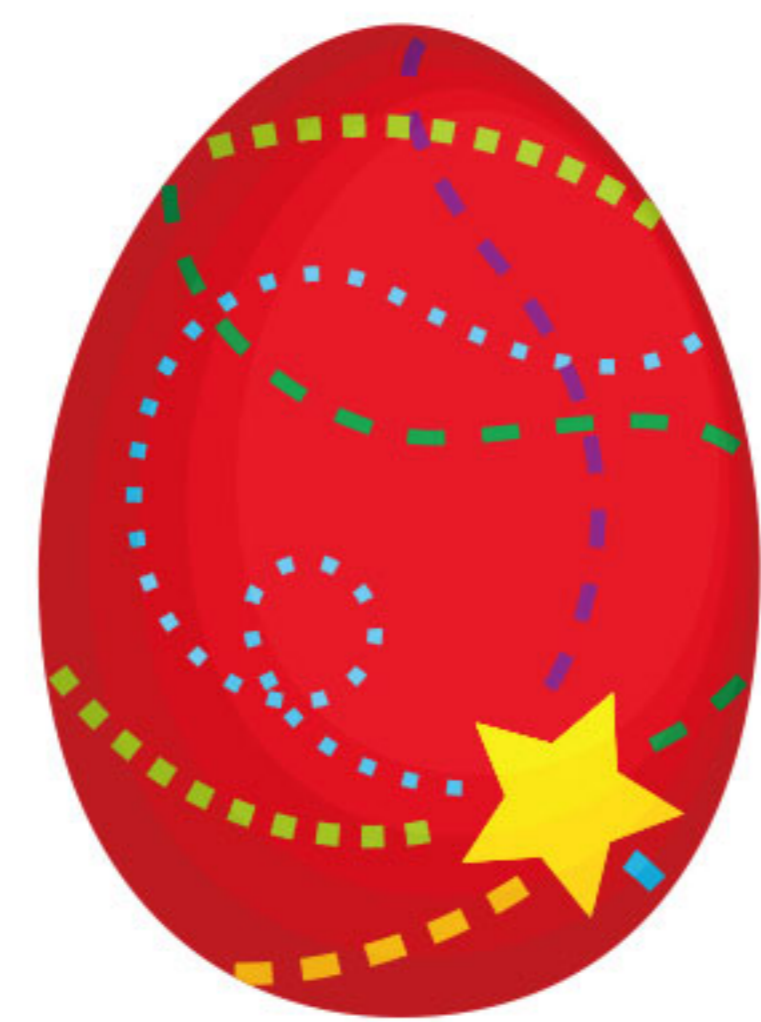
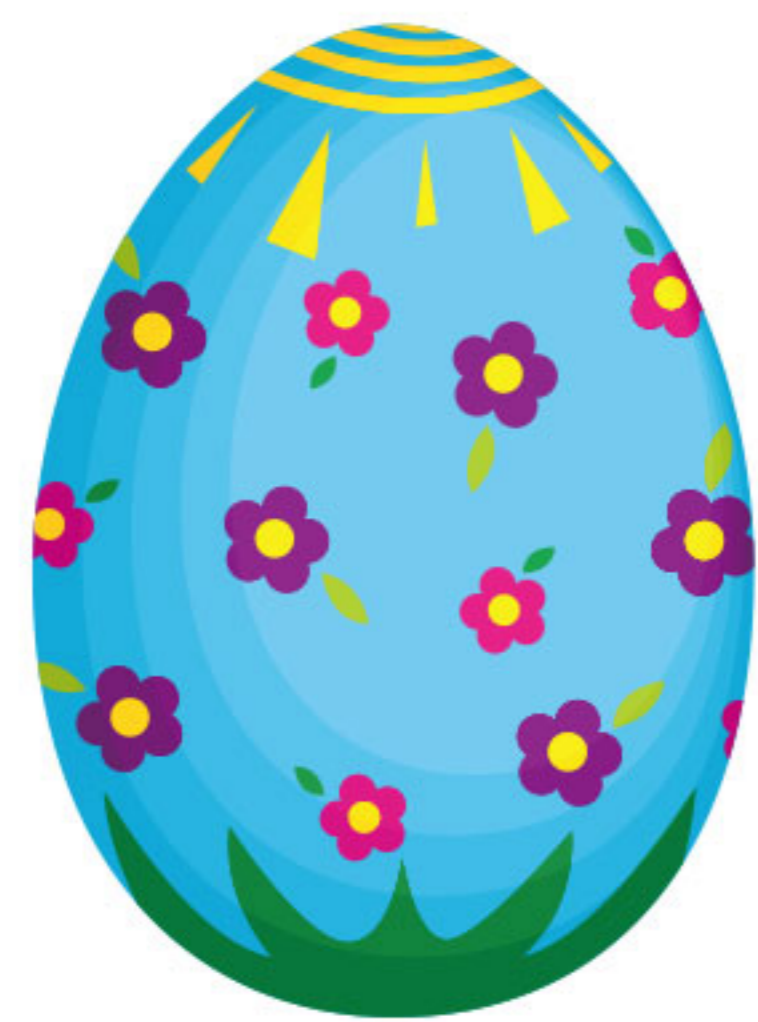



FICHAS PARA TRABAJAR

# NÚMEROS

---





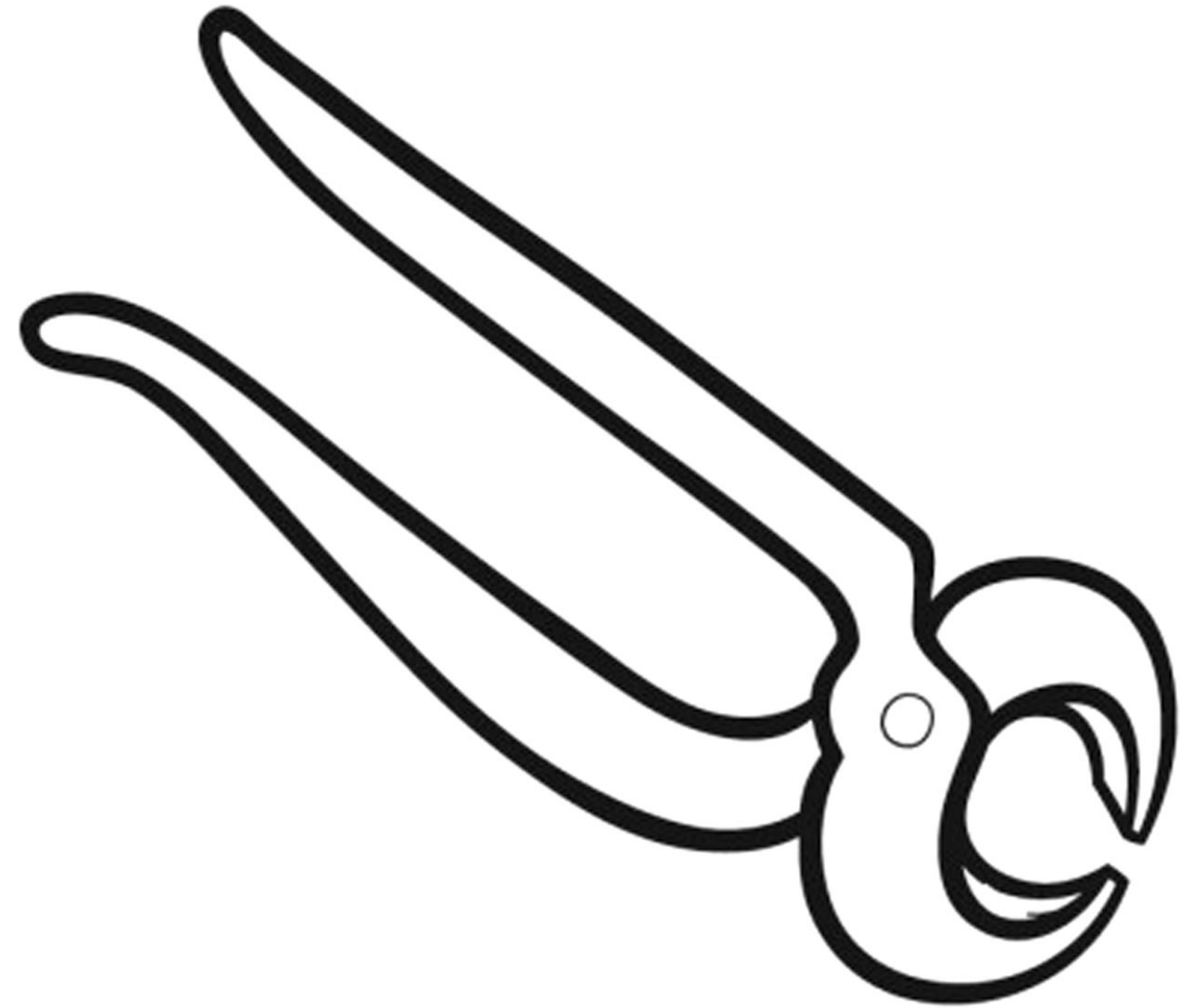
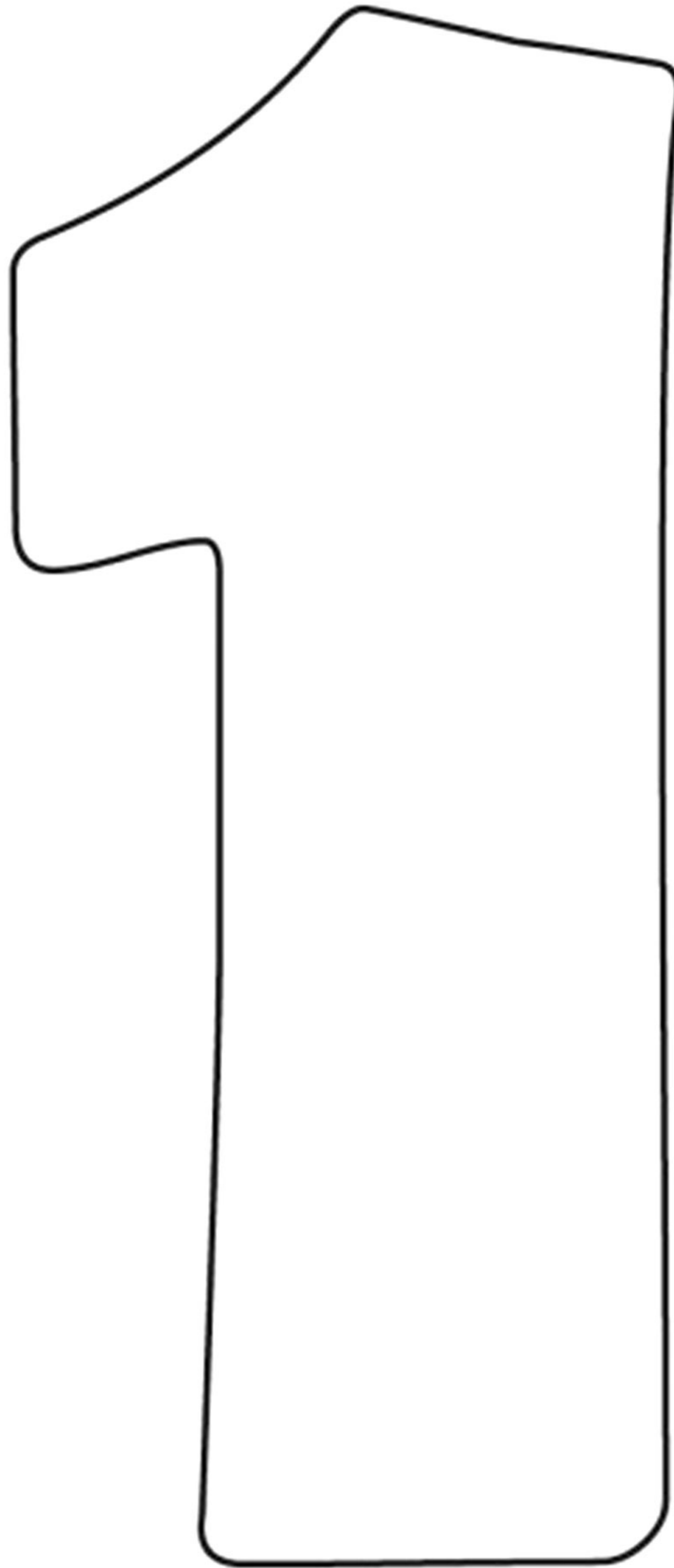

UNO



Colorea 2 manzanas.

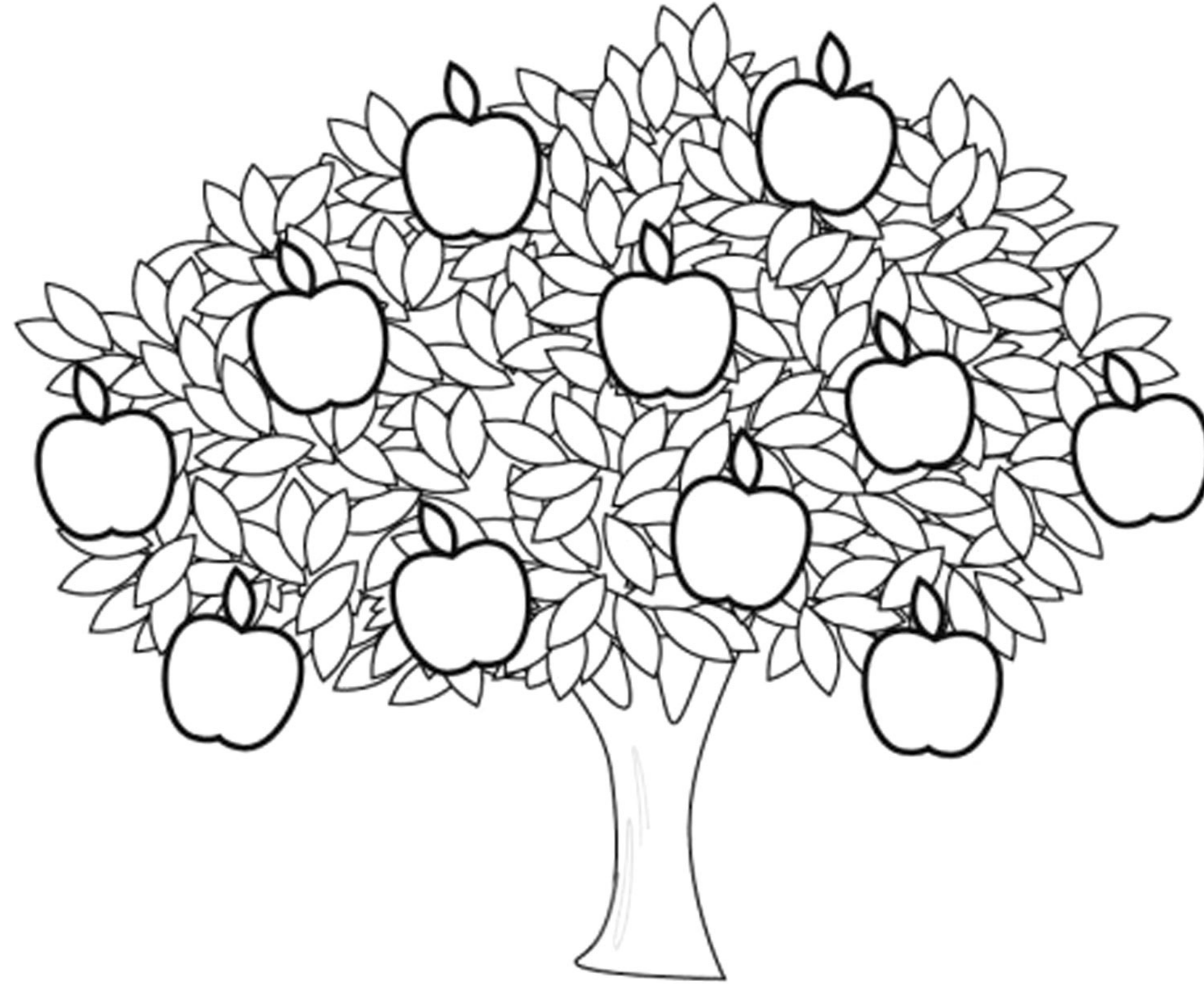
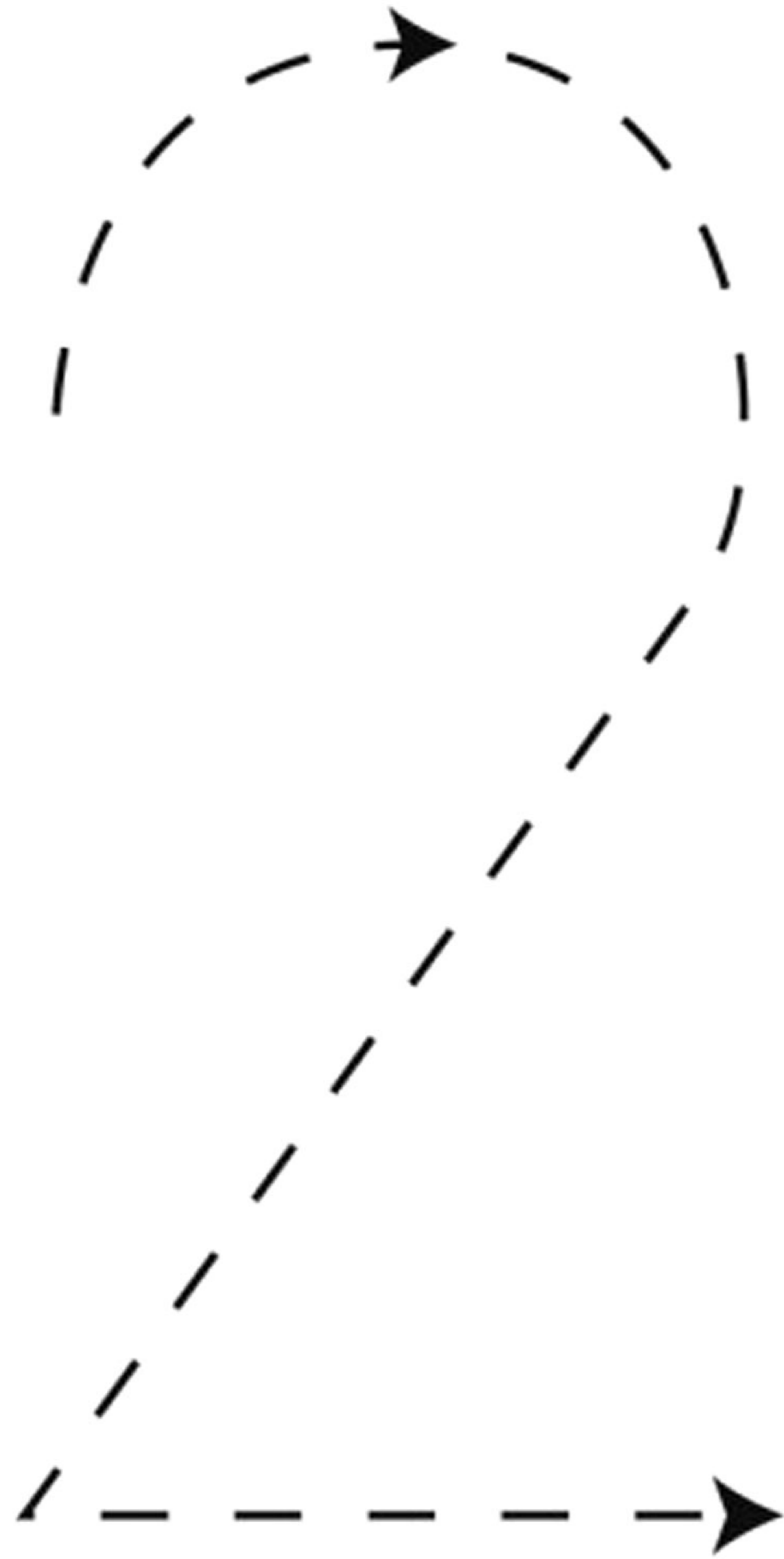

DOS



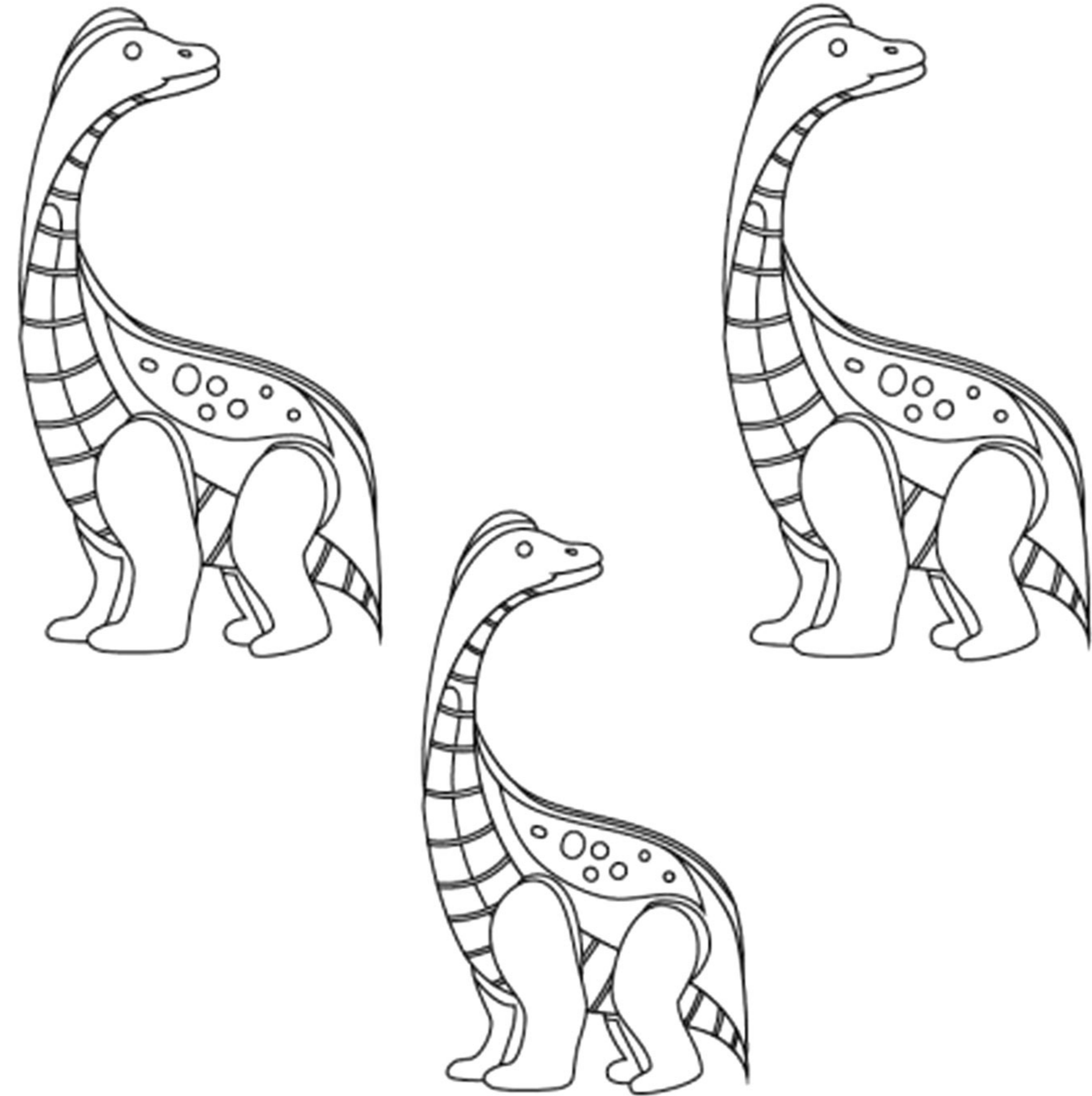
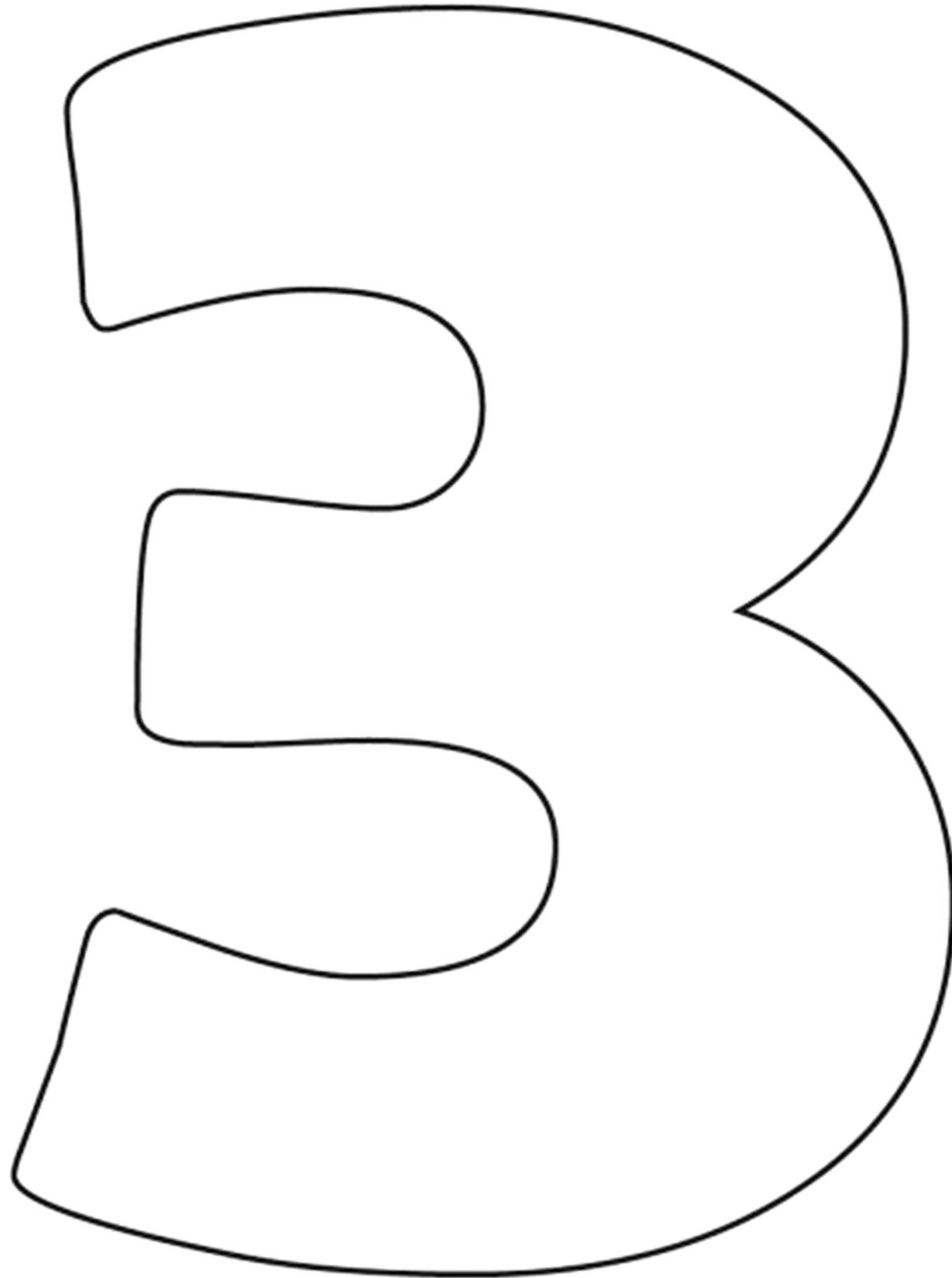

TRES



Colorea 4 animales.

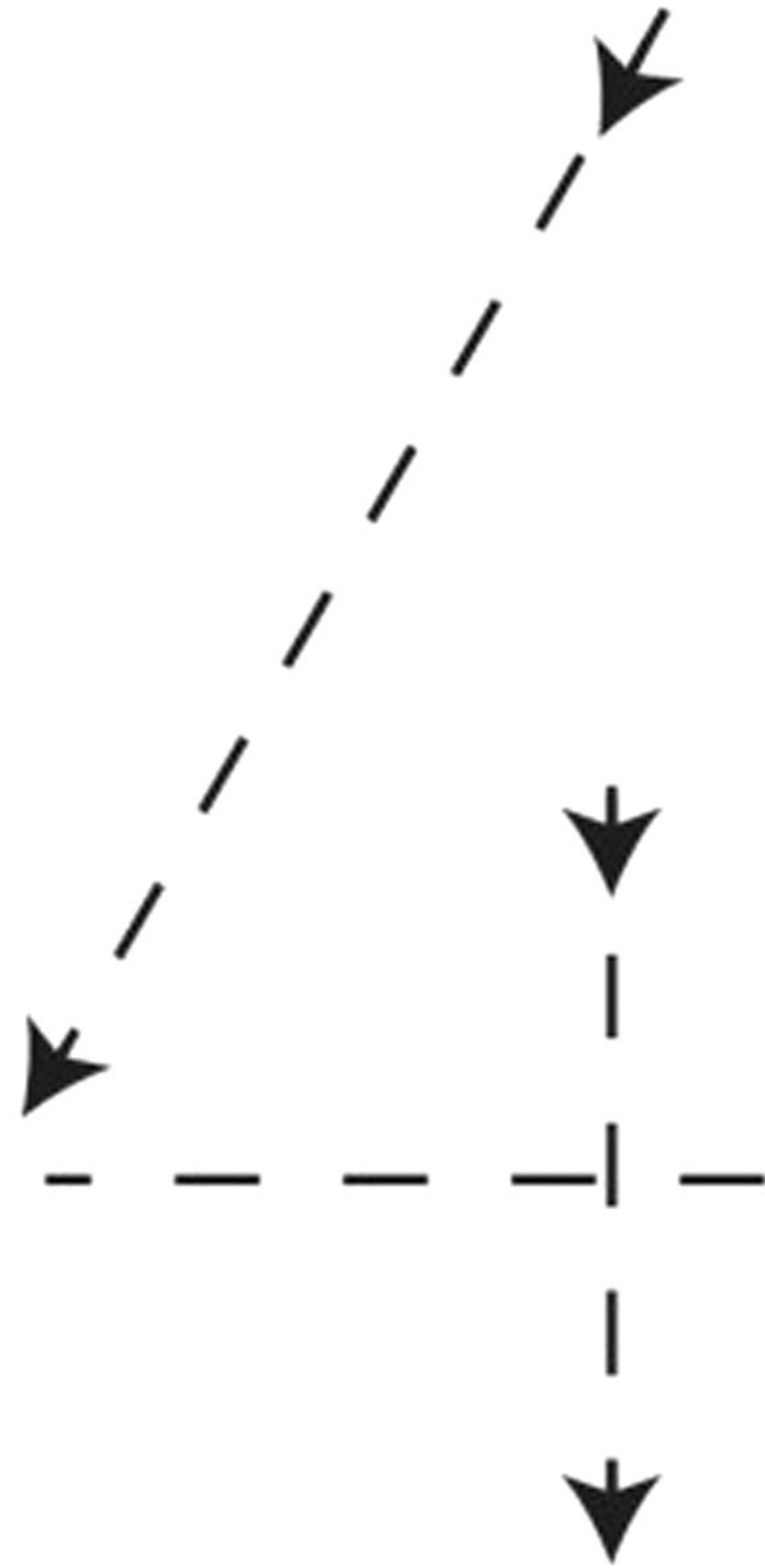

CUATRO



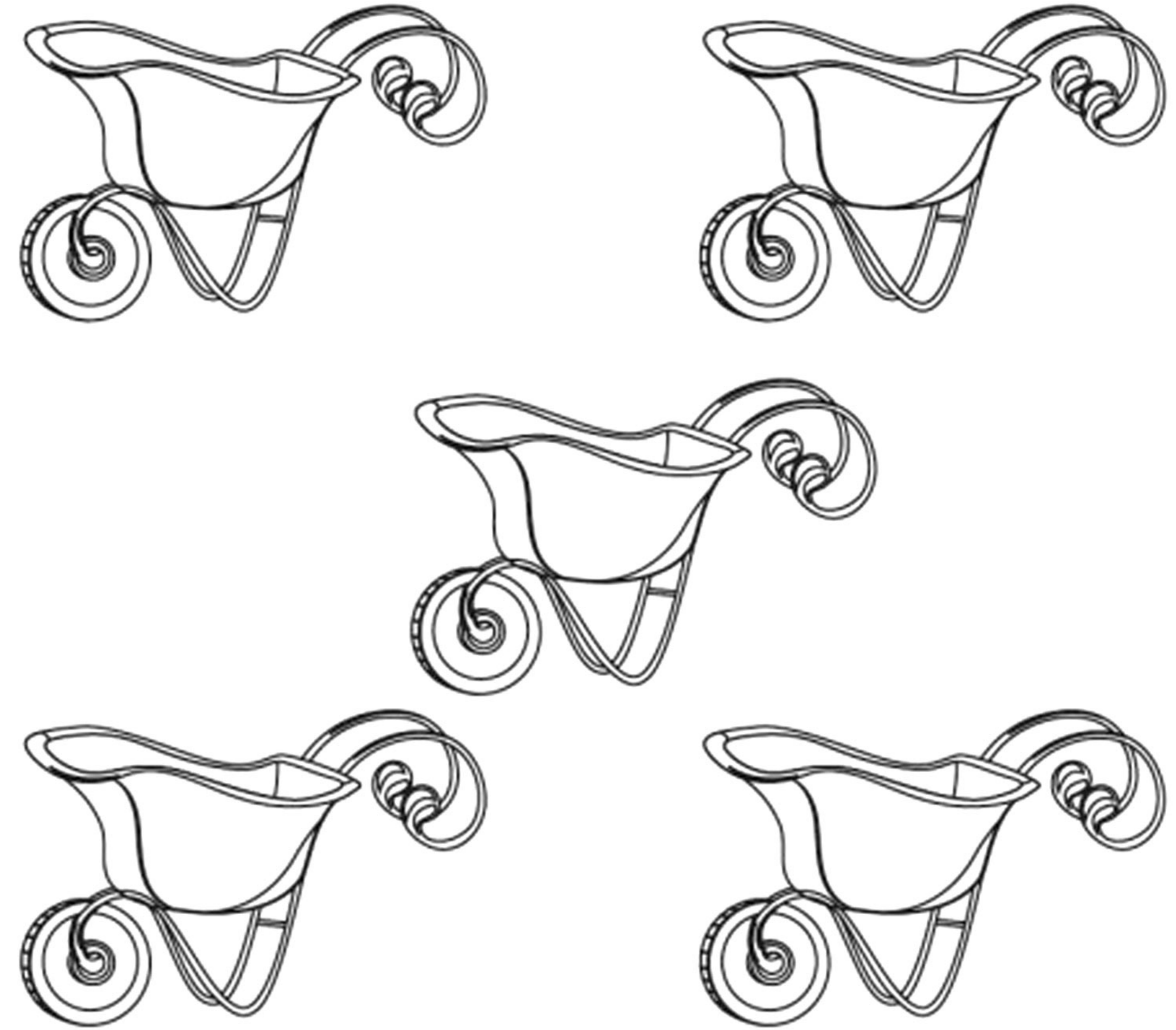

CINCO



Colorea 6 manzanas.

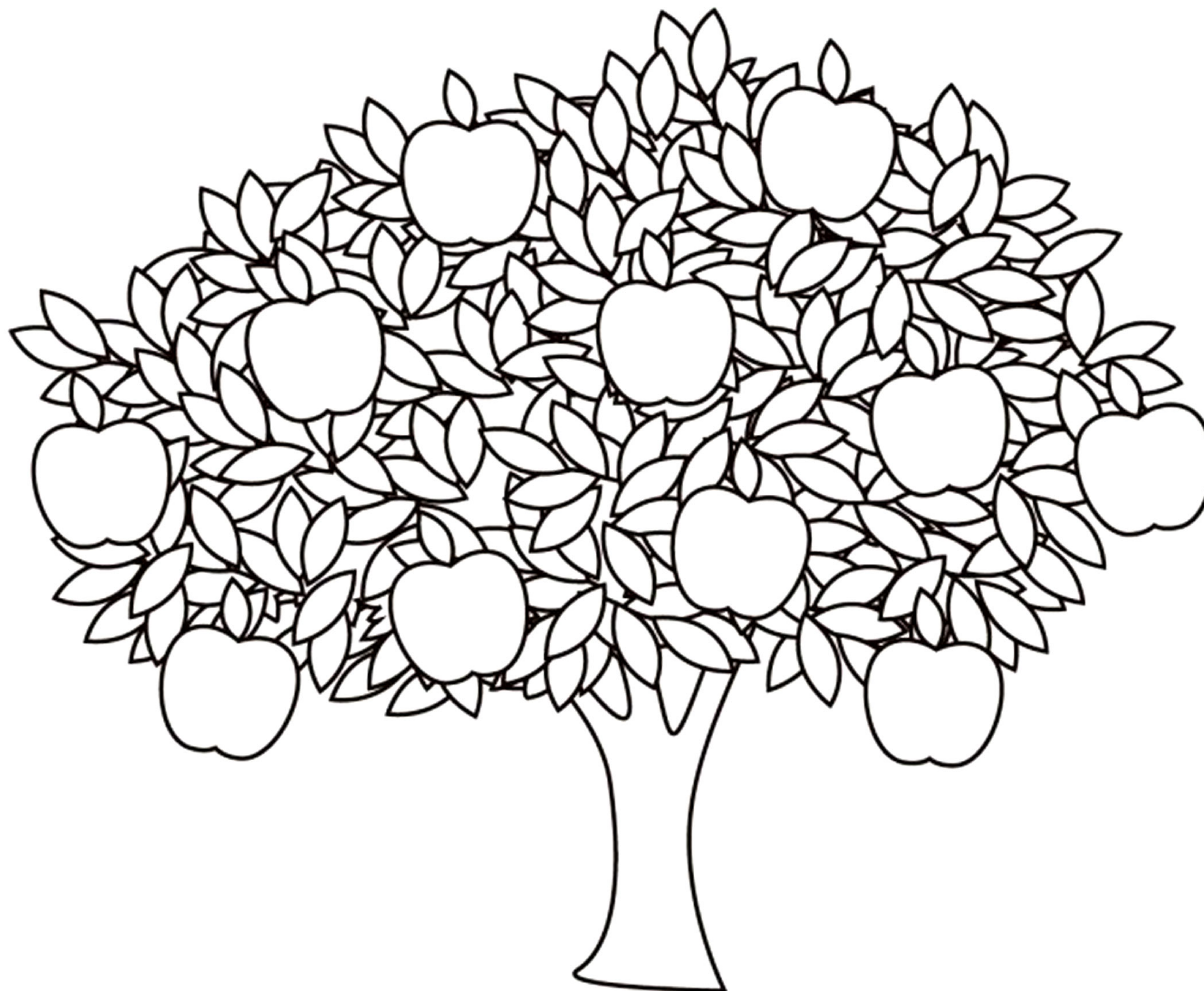
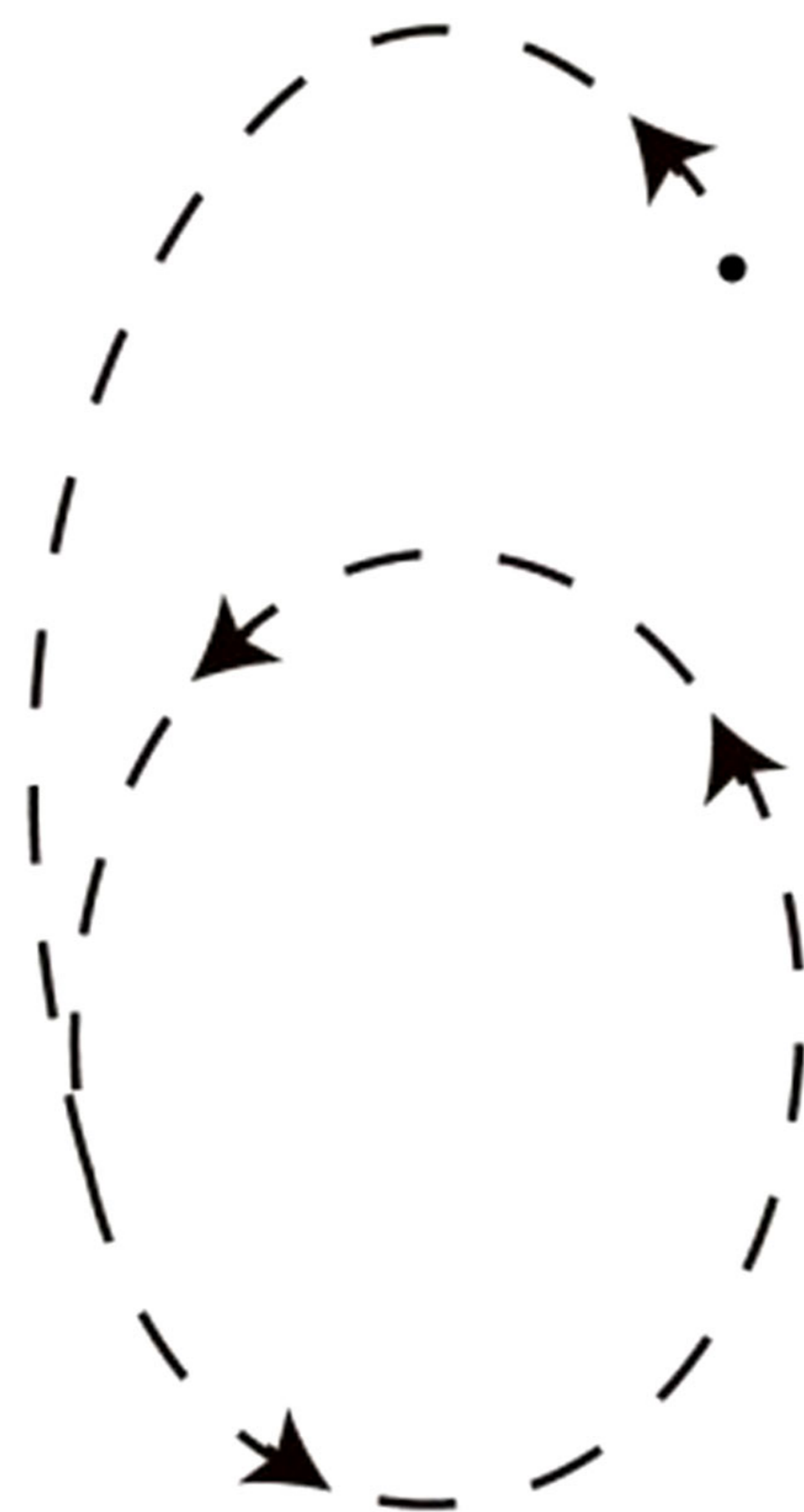



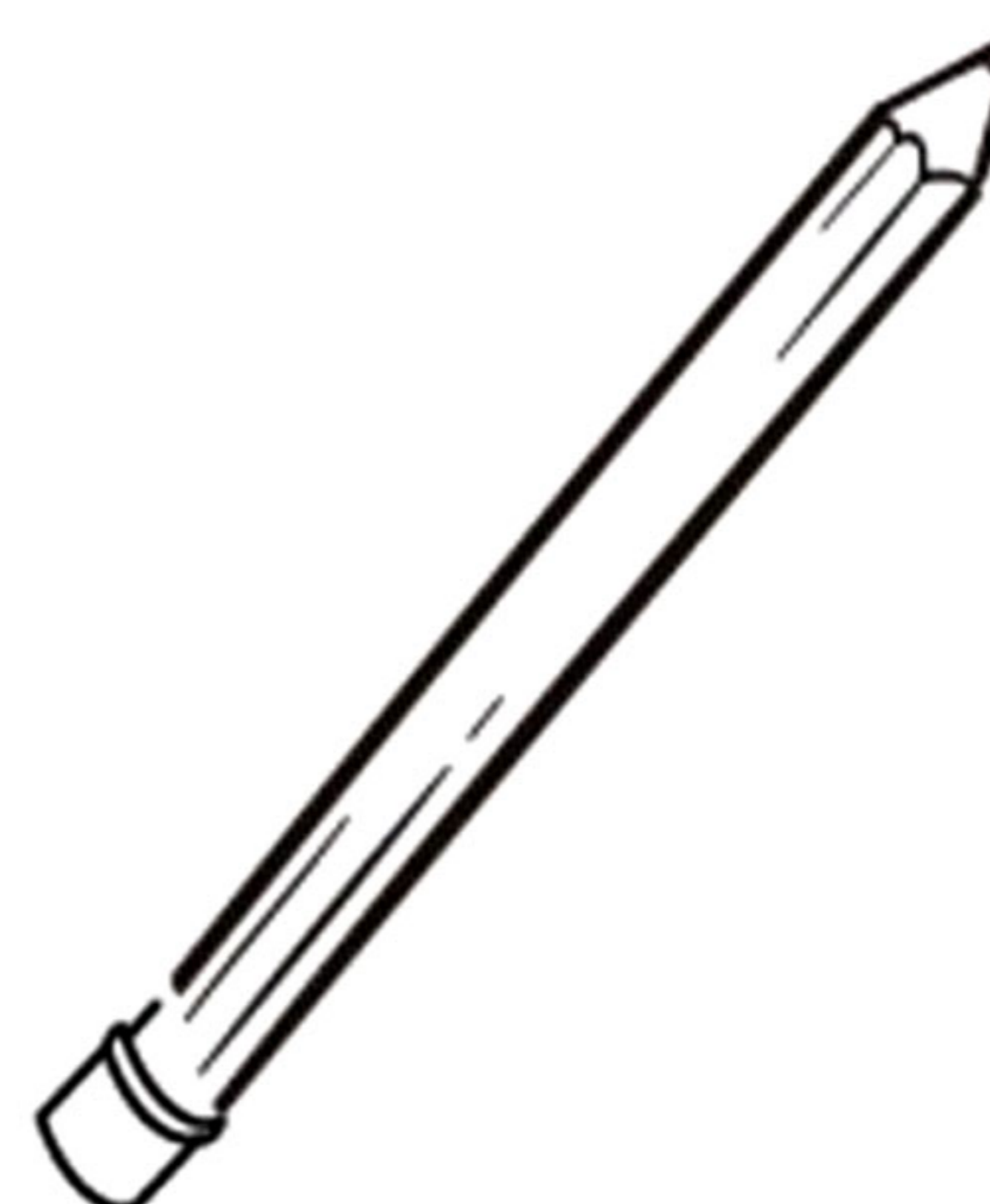
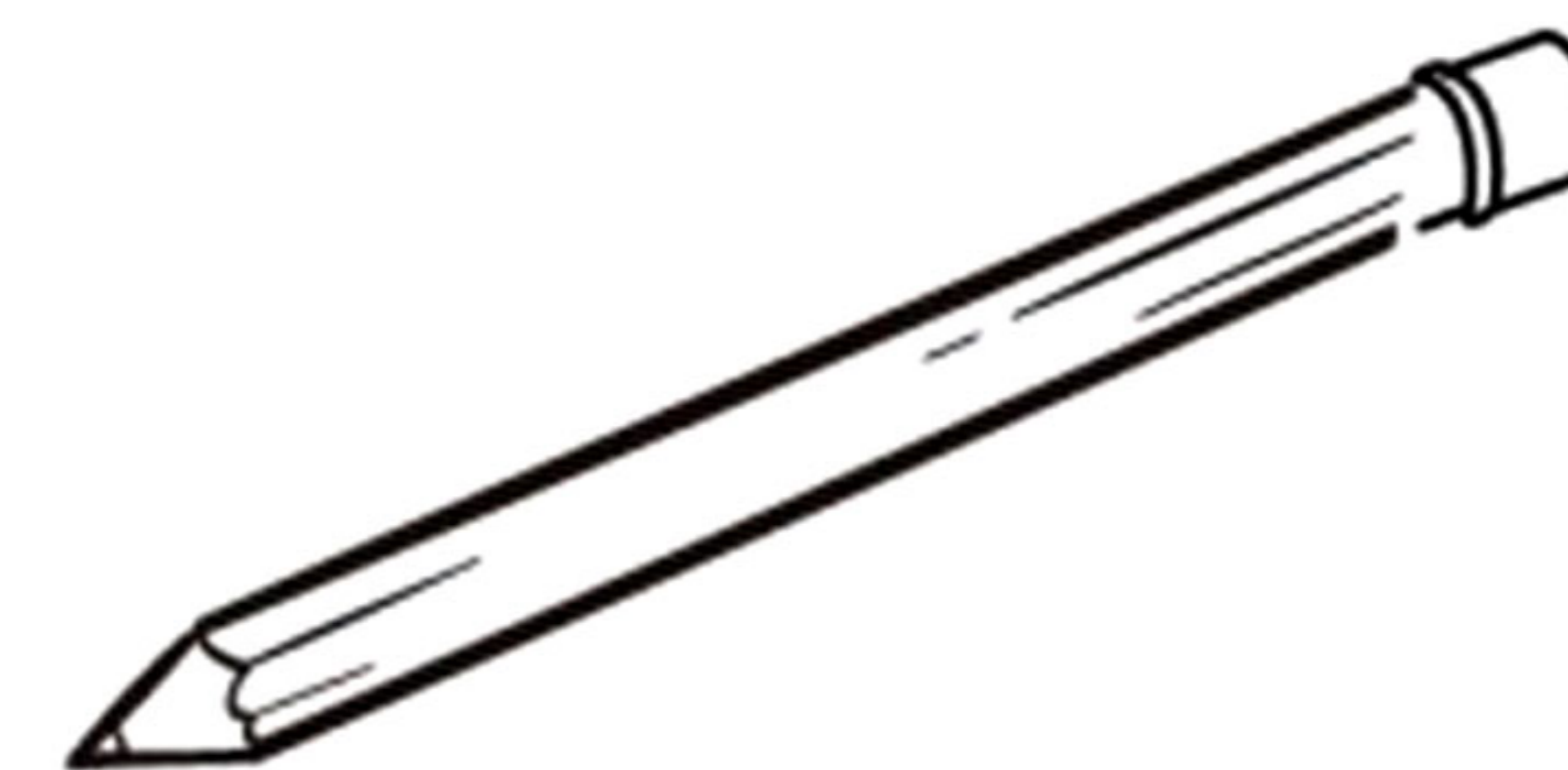
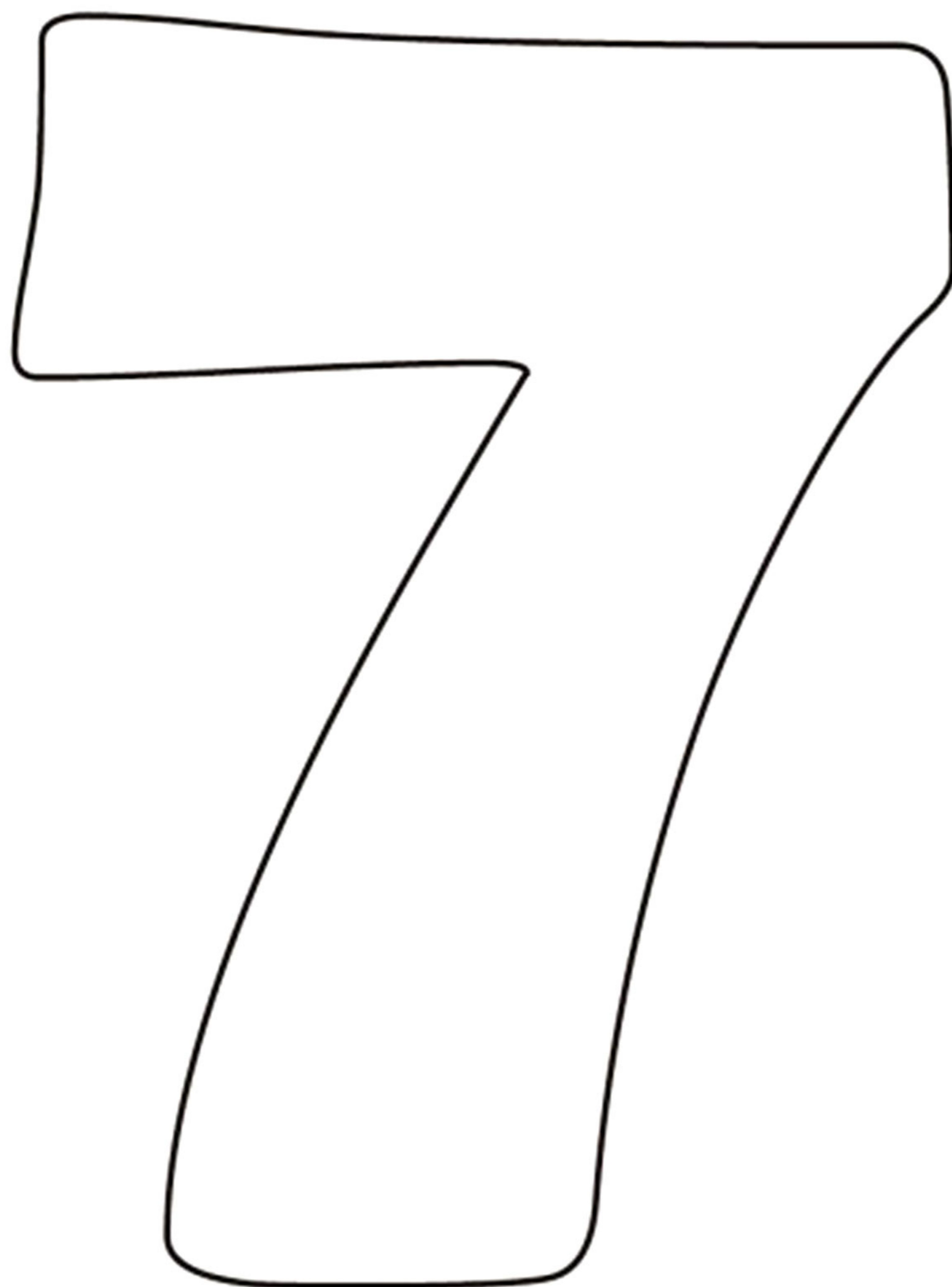



Colorea 8 bolos.

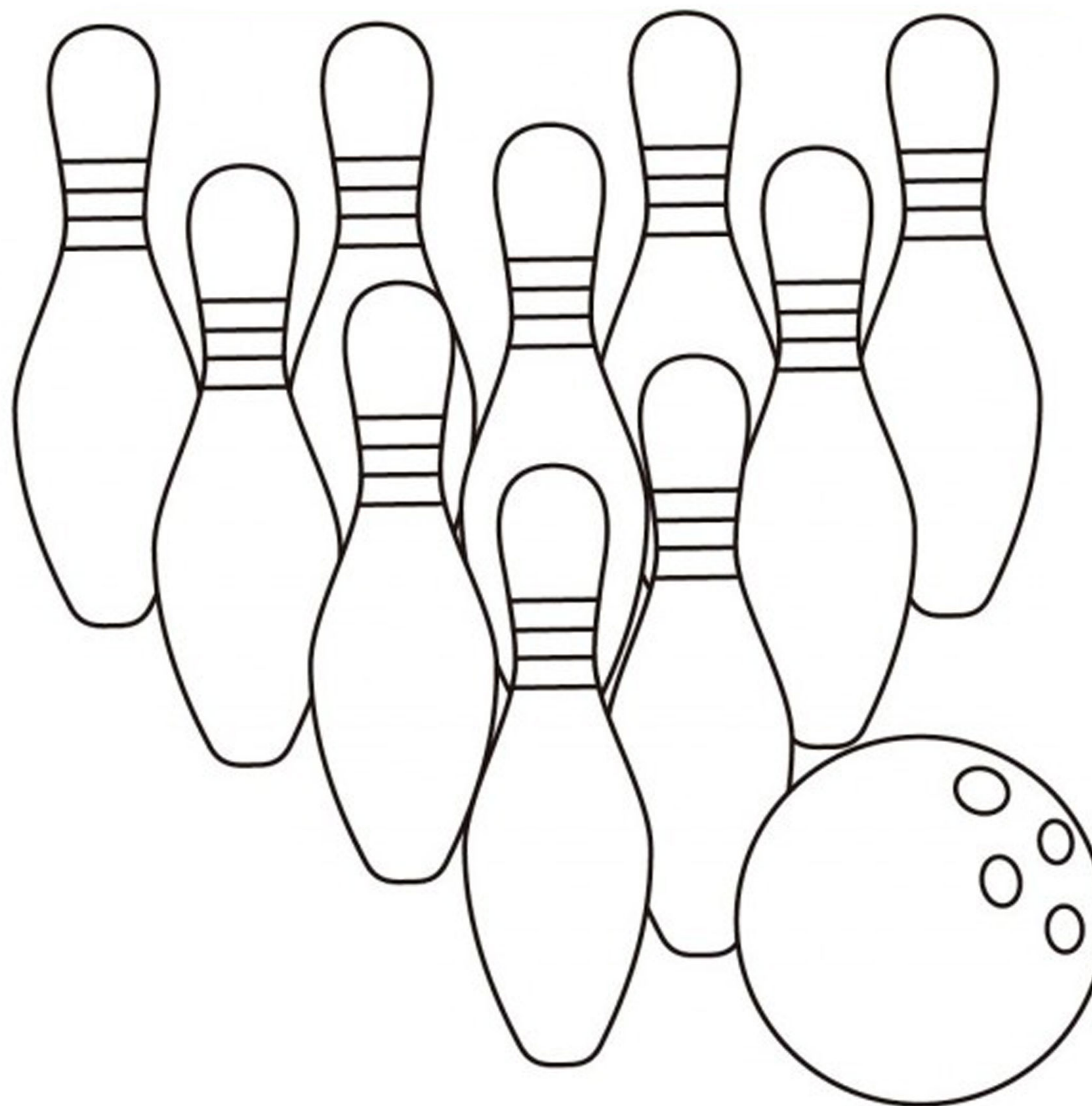
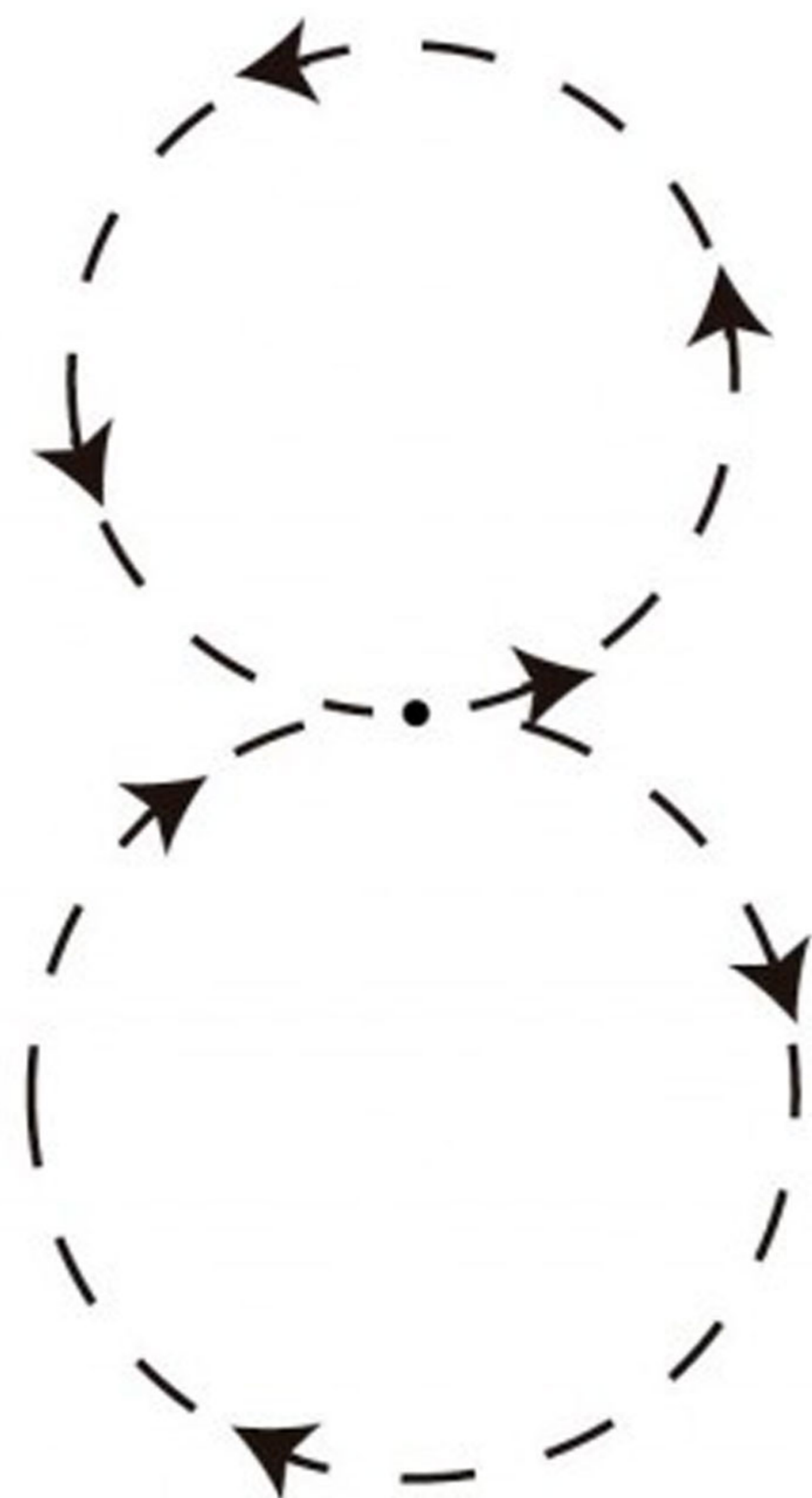



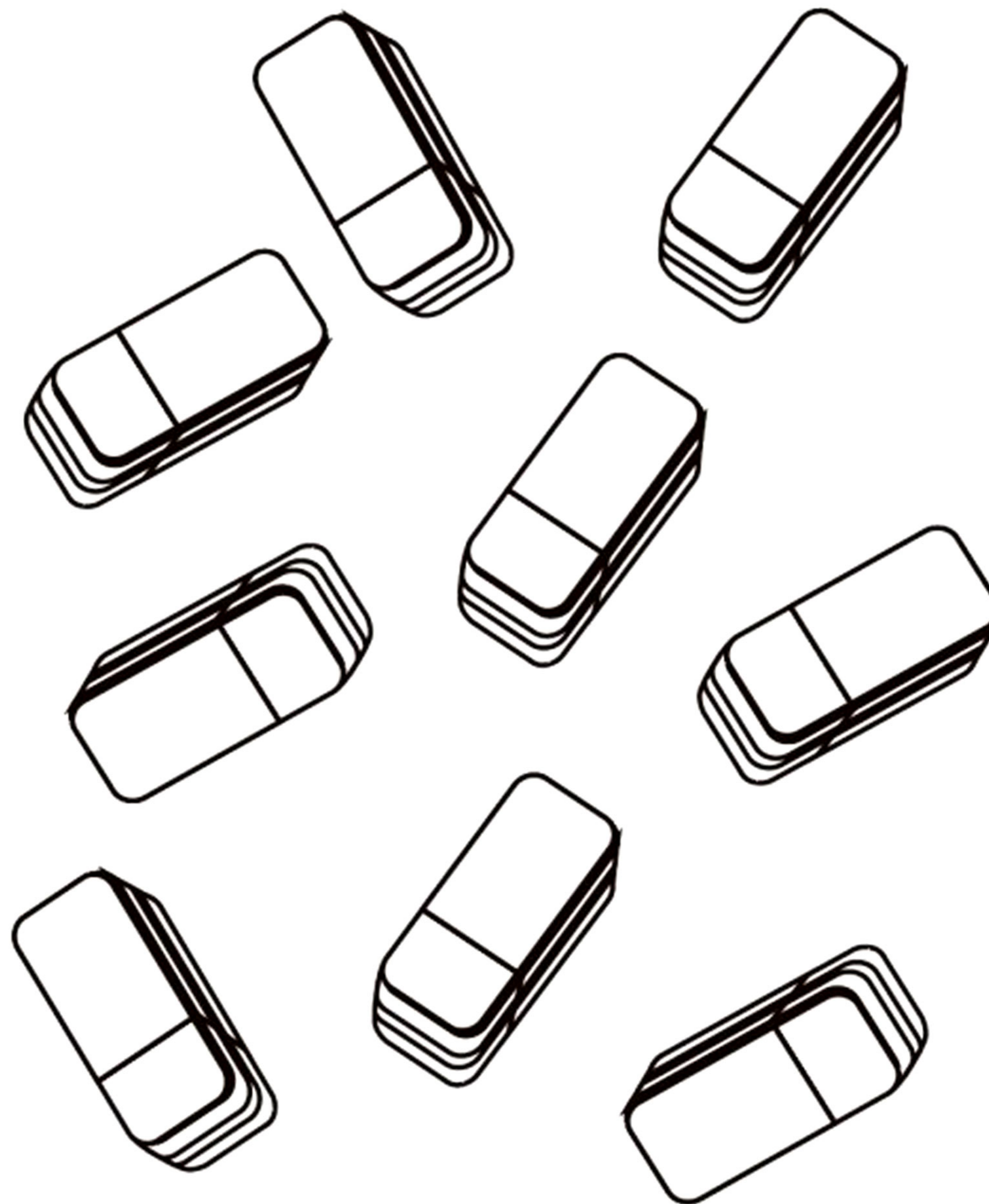
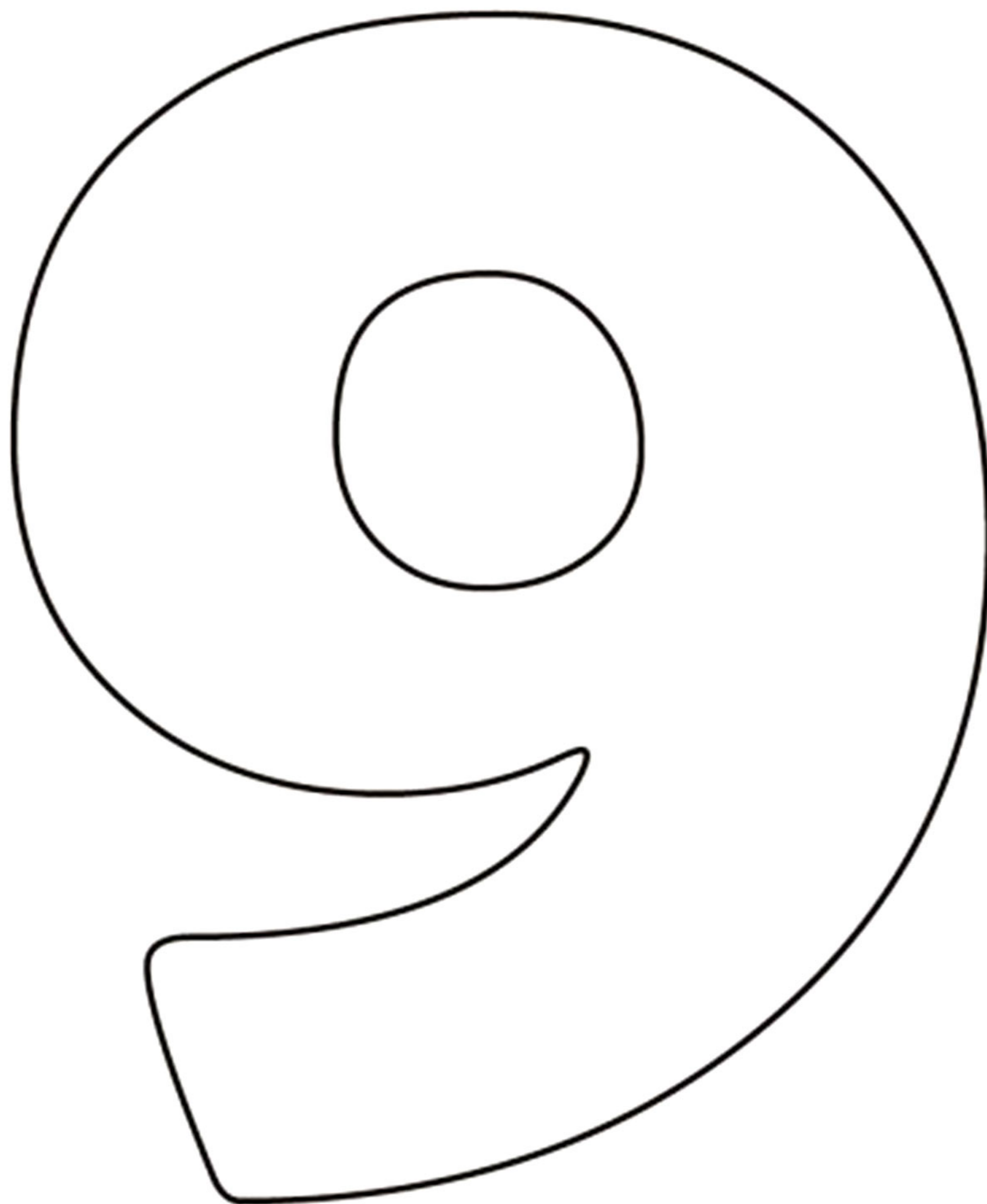



Colorea 10 hojas secas.

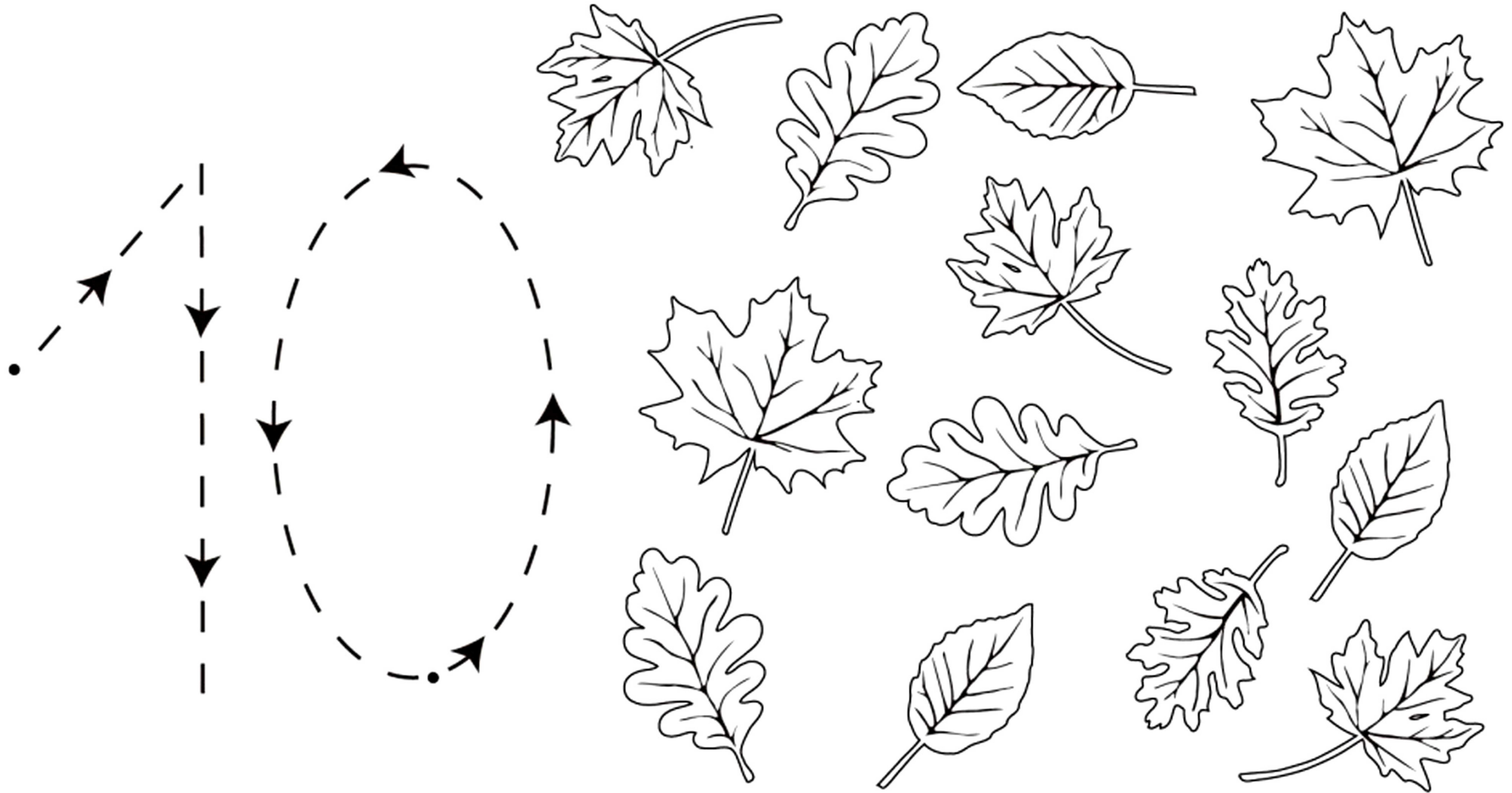



FICHAS DE

# ESCRITURA

---





# Repasa los nombres de los objetos

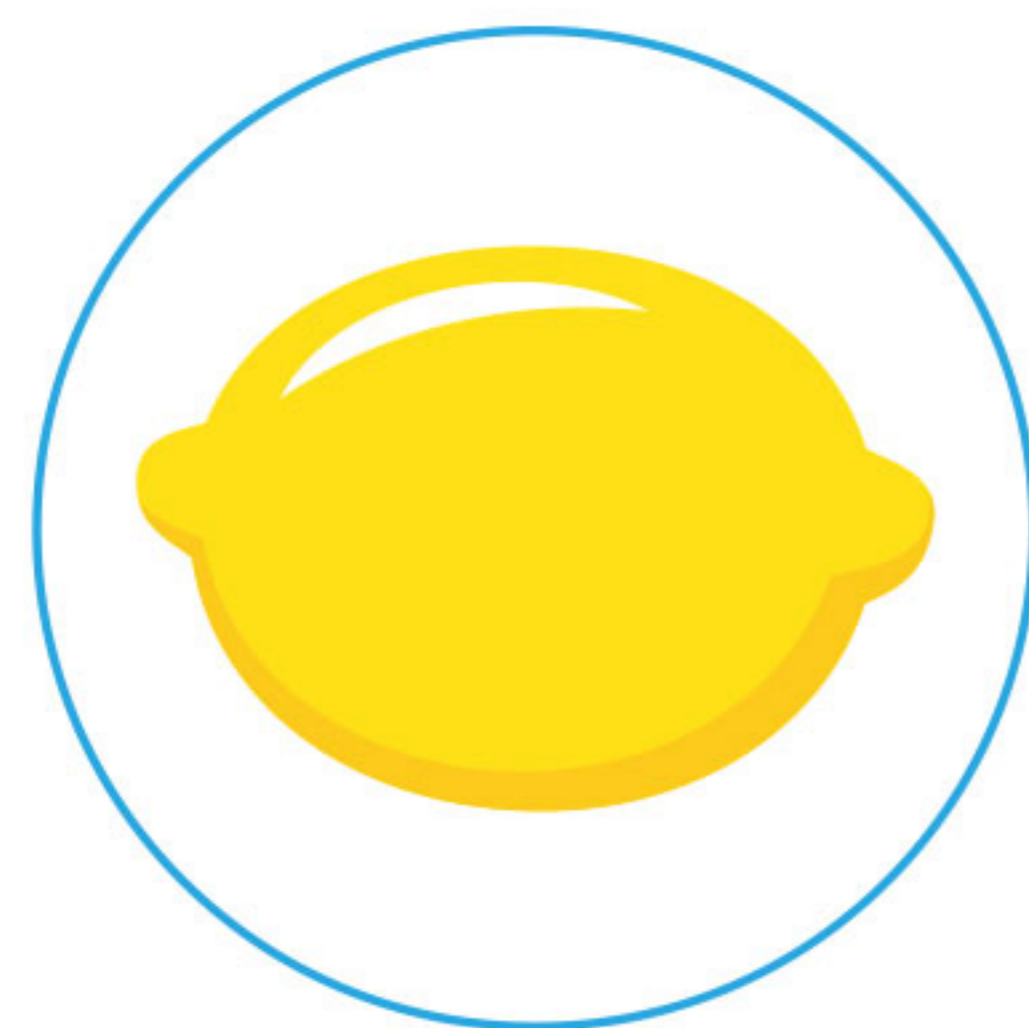

limón



pelota



caballo



avión



# Repasa los nombres de los objetos



autobús



cuaderno



mochila



lápiz



# Repasa los nombres de los objetos



caracol



tigre



vaca

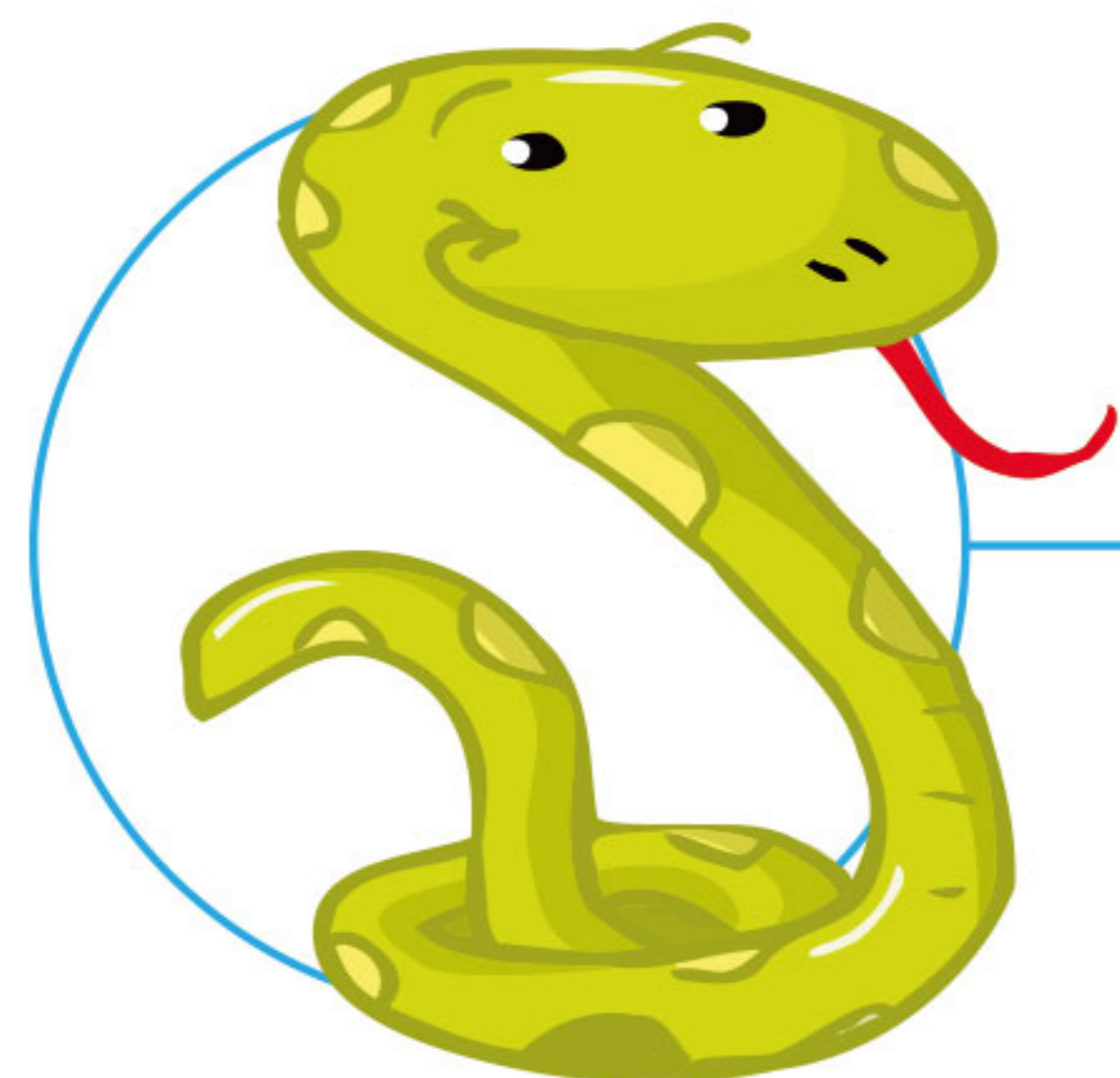

serpiente



# Repasa los nombres de los objetos



tesoro



pirata



luna



sol



# Repasa los nombres de los objetos



zapatilla



sombrero

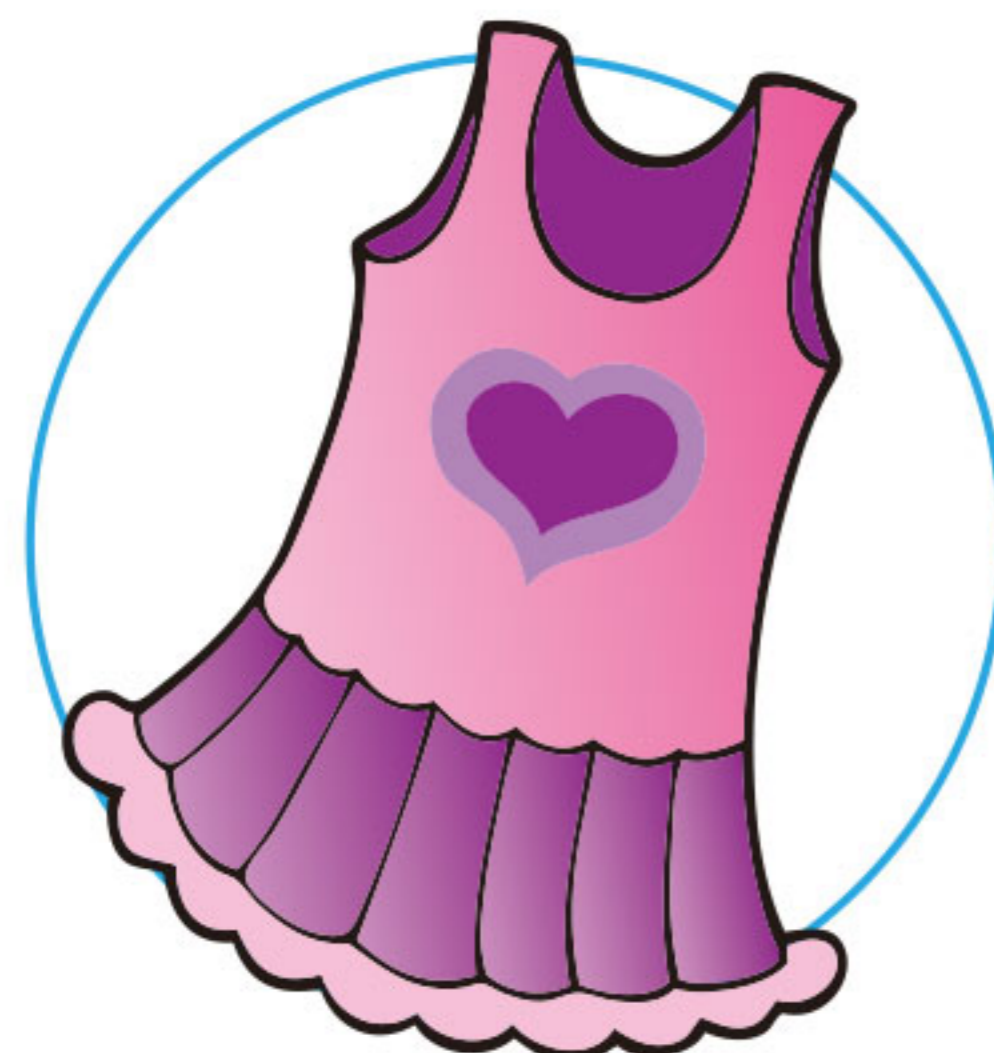

vestido

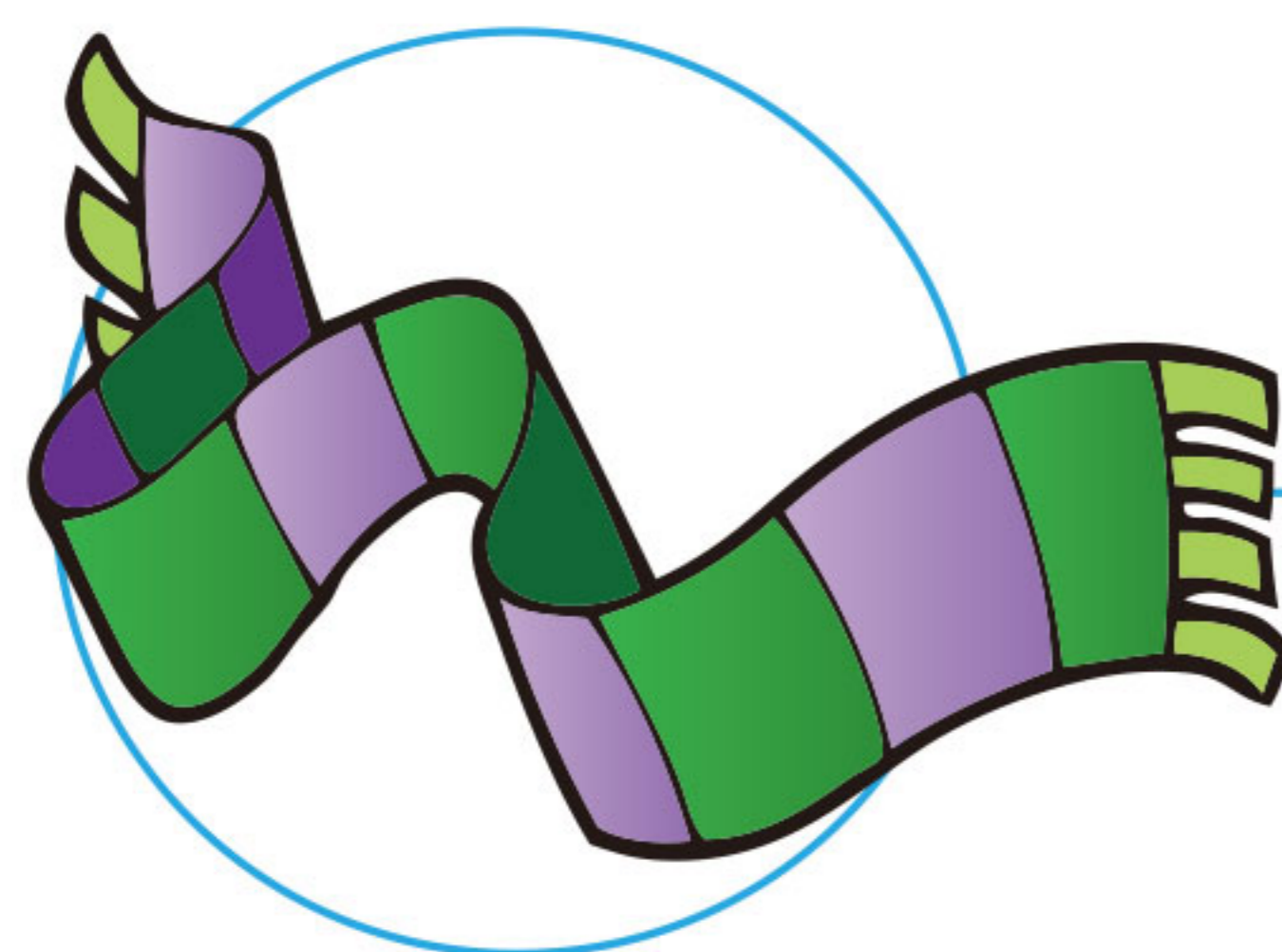

bufanda



Escribe el nombre del objeto fijándote  
en el modelo

bota



taza





Escribe el nombre del objeto fijándote  
en el modelo

galleta



helado





Escribe el nombre del objeto fijándote  
en el modelo

manzana



mochila





FICHAS DE  
**LECTURA**

---

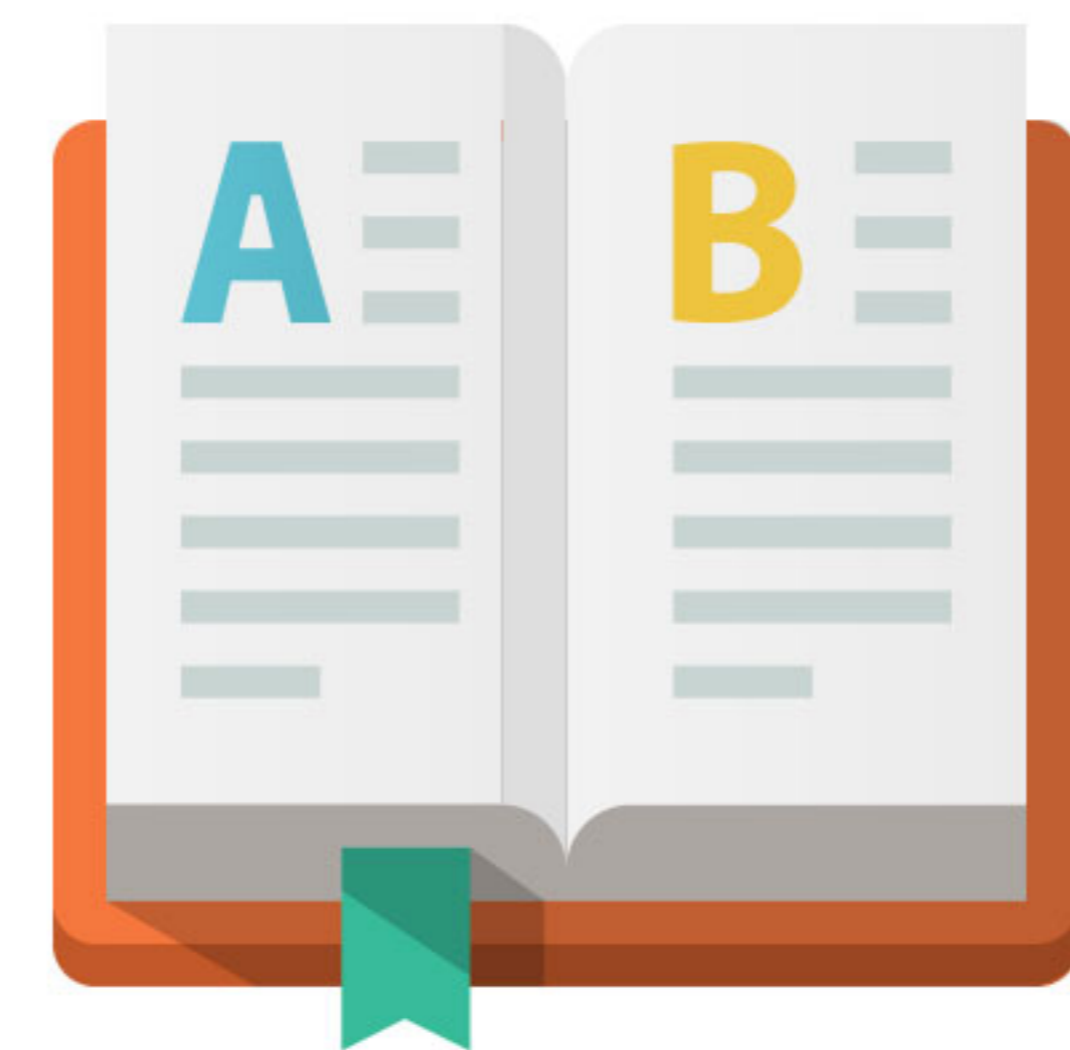



Une con una flecha el objeto y su nombre

Piano

Koala

Helado

Submarino





Une con una flecha el objeto y su nombre

Pájaro

Pelota

Coche

Zapatilla





Une con una flecha el objeto y su nombre

Oso de peluche

Luna

Jarrón

Chupete





Une con una flecha el objeto y su nombre

Camgrajo

Corona

Barco

Perro

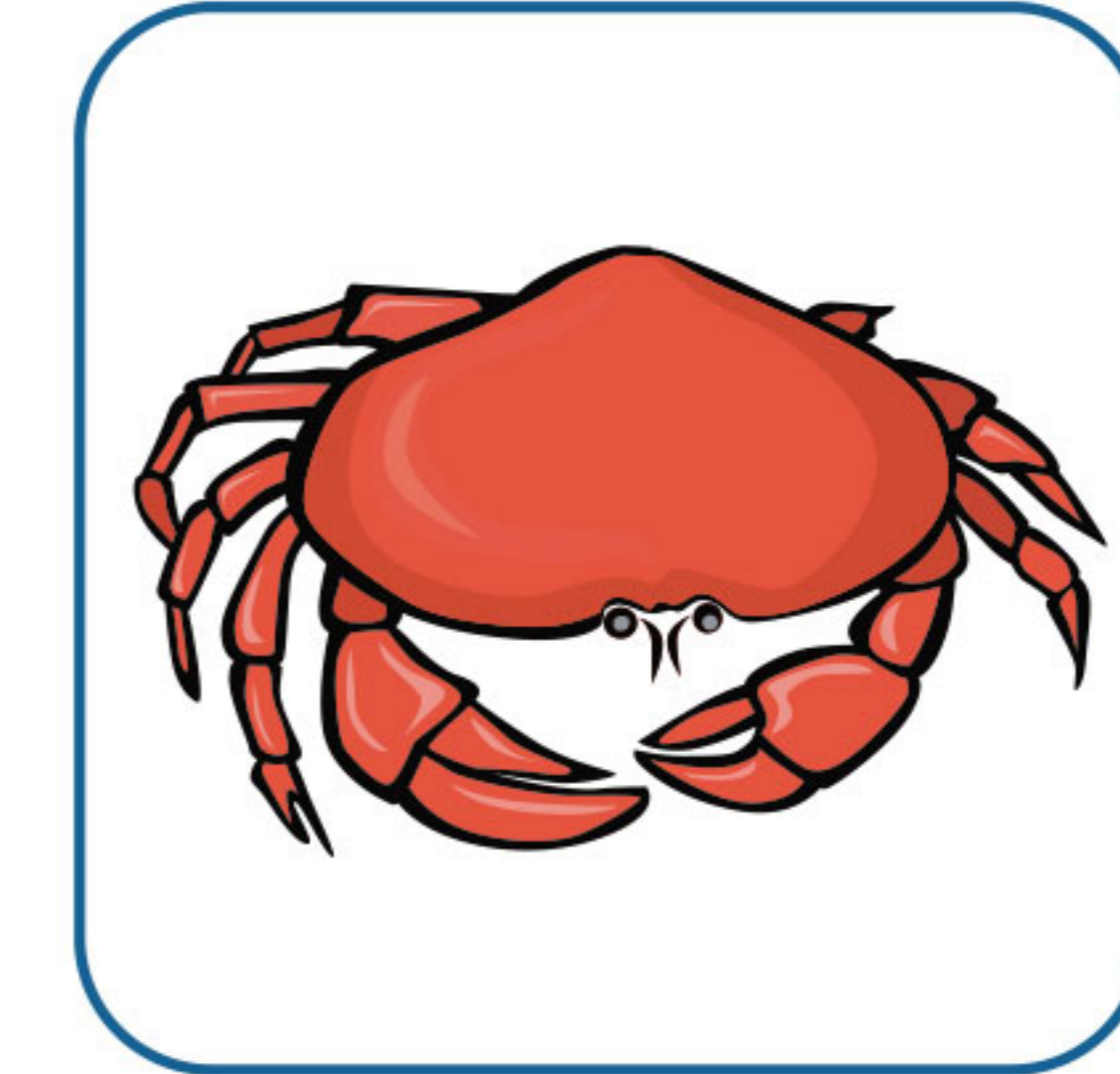



Une con una flecha el objeto y su nombre

Cohete

Robot

Sonajero

Delfín

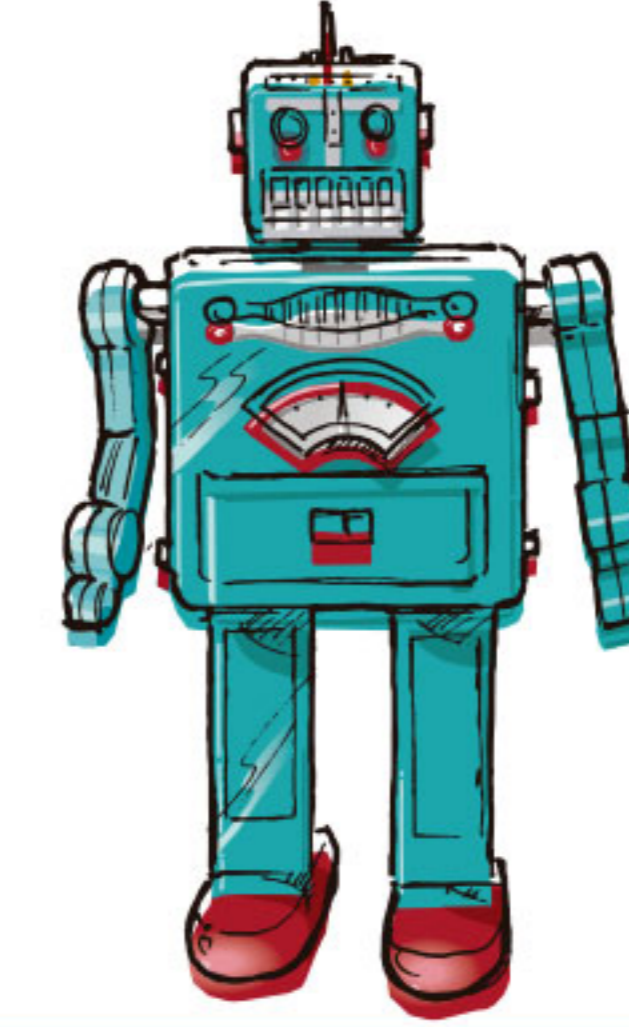



FICHAS DE  
**CÁLCULO**

---

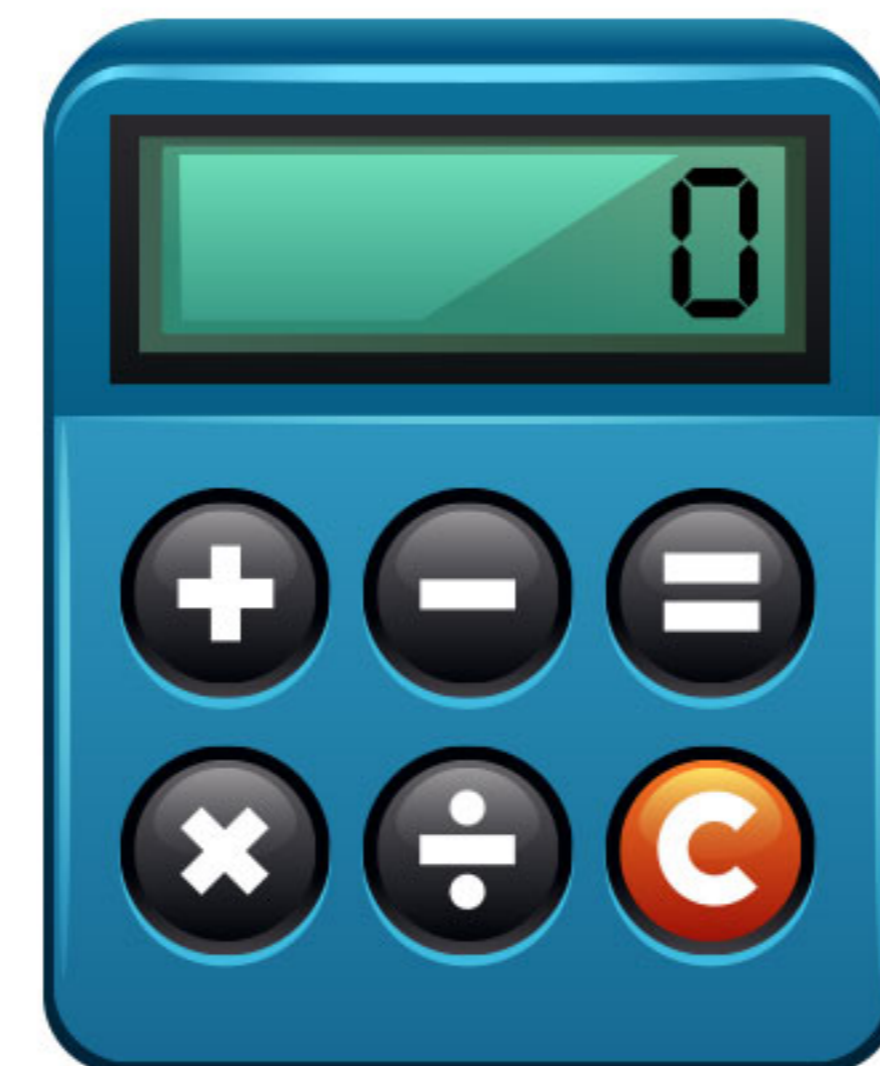



Escribe el resultado de las cuentas en el círculo vacío.

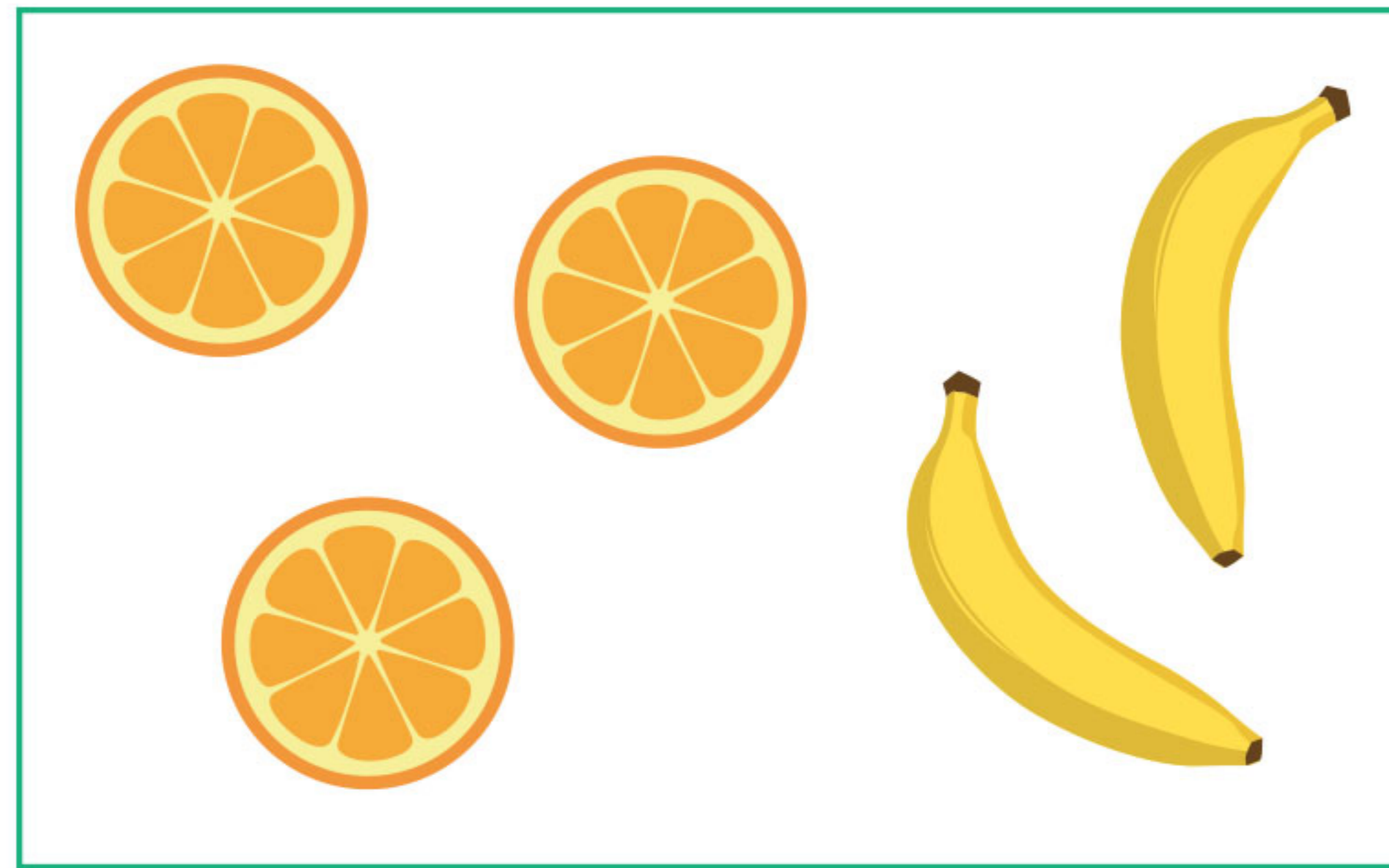

$$3 + 2 = \bigcirc$$



$$4 - 1 = \bigcirc$$



$$5 + 2 = \bigcirc$$



Escribe el resultado de las cuentas en el círculo vacío.

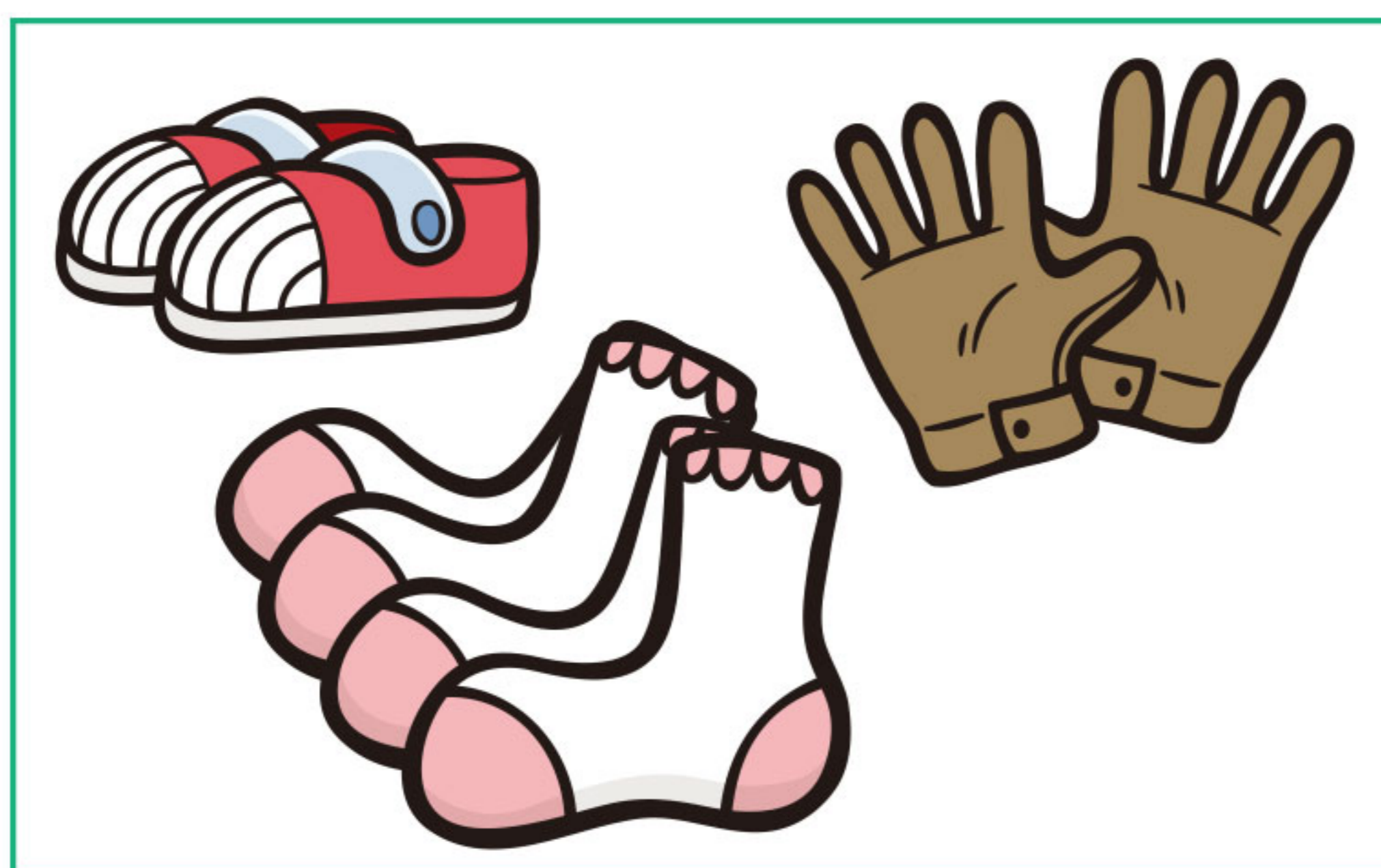

$$4 + \quad + 2 = 8$$

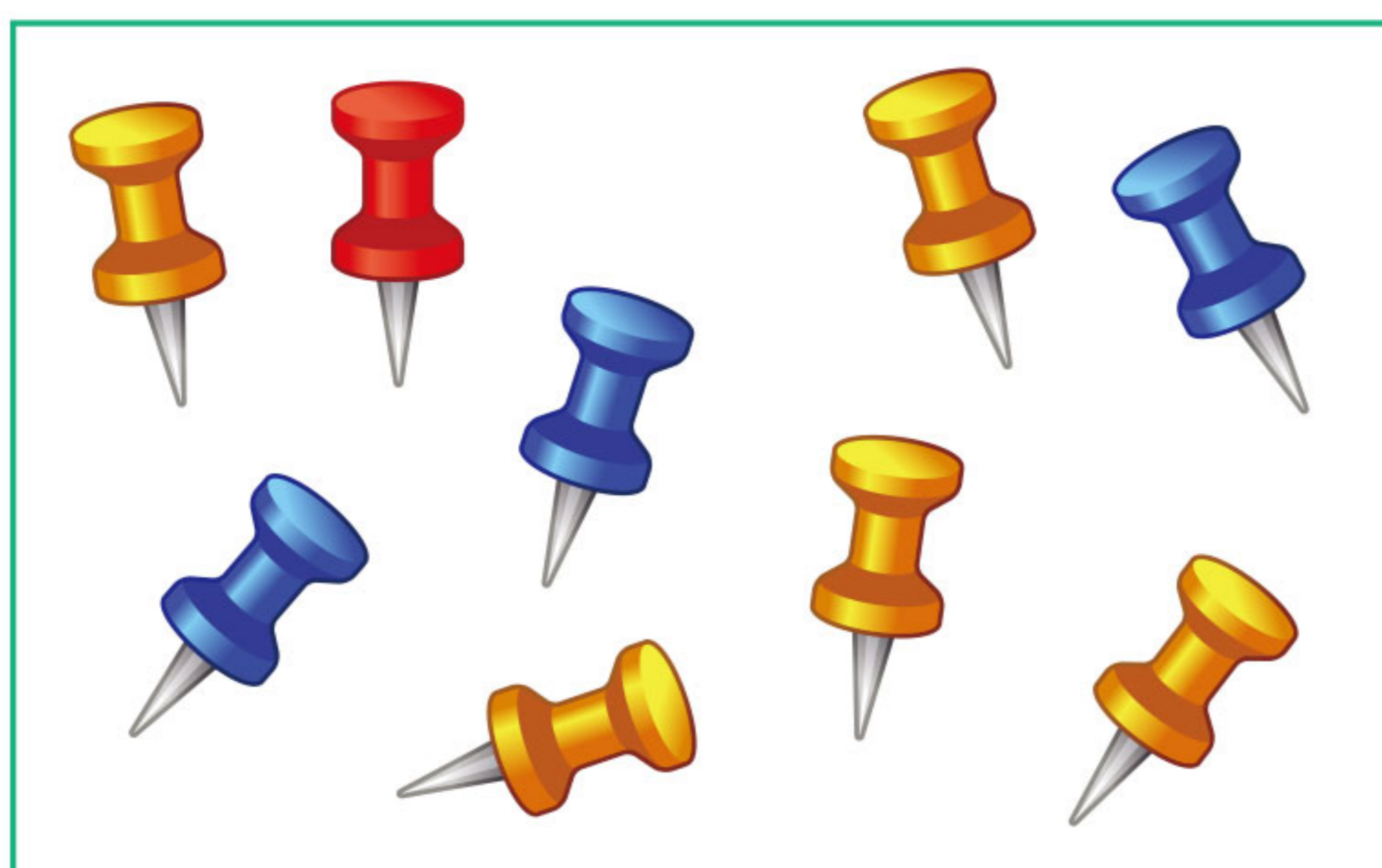

$$1 + 3 + \quad = 9$$



$$9 - 2 = \quad$$



$$\begin{array}{r} + 5 \\ 2 \\ \hline \end{array}$$

$$\begin{array}{r} + 4 \\ 1 \\ \hline \end{array}$$

$$\begin{array}{r} + 3 \\ 2 \\ \hline \end{array}$$

$$\begin{array}{r} 8 \\ - 2 \\ \hline \end{array}$$

$$\begin{array}{r} 9 \\ - 1 \\ \hline \end{array}$$

$$\begin{array}{r} 3 \\ - 3 \\ \hline \end{array}$$



$$\begin{array}{r} + 1 \\ 2 \\ \hline \end{array}$$

$$\begin{array}{r} + 1 \\ 1 \\ \hline \end{array}$$

$$\begin{array}{r} + 2 \\ 2 \\ \hline \end{array}$$

$$\begin{array}{r} 4 \\ - 2 \\ \hline \end{array}$$

$$\begin{array}{r} 3 \\ - 1 \\ \hline \end{array}$$

$$\begin{array}{r} 2 \\ - 1 \\ \hline \end{array}$$



Rodea el conjunto de objetos que representa la suma

$$5 + 2 = 7$$

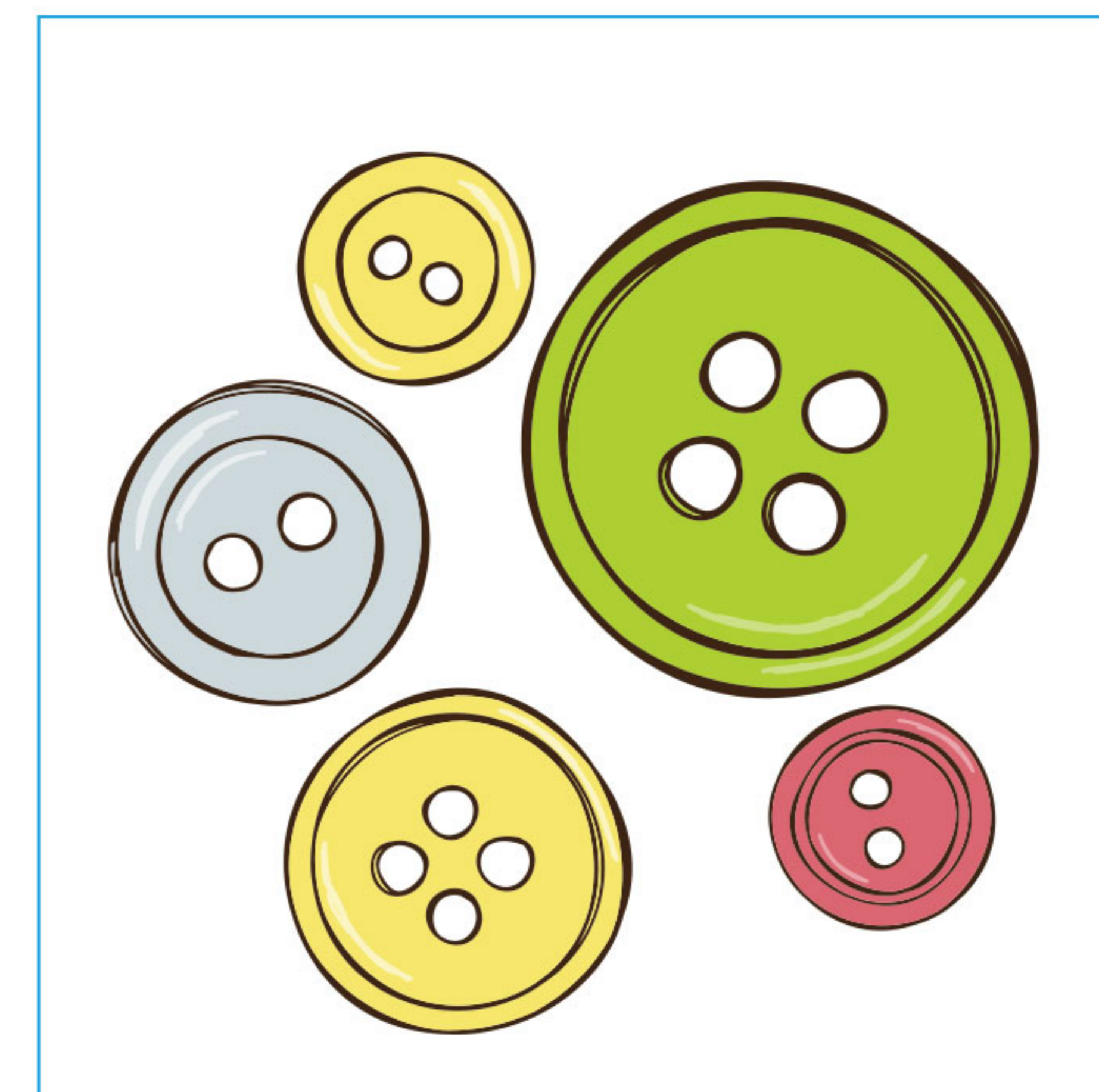



Rodea el conjunto de objetos que representa la suma

$$3 + 3 = 6$$

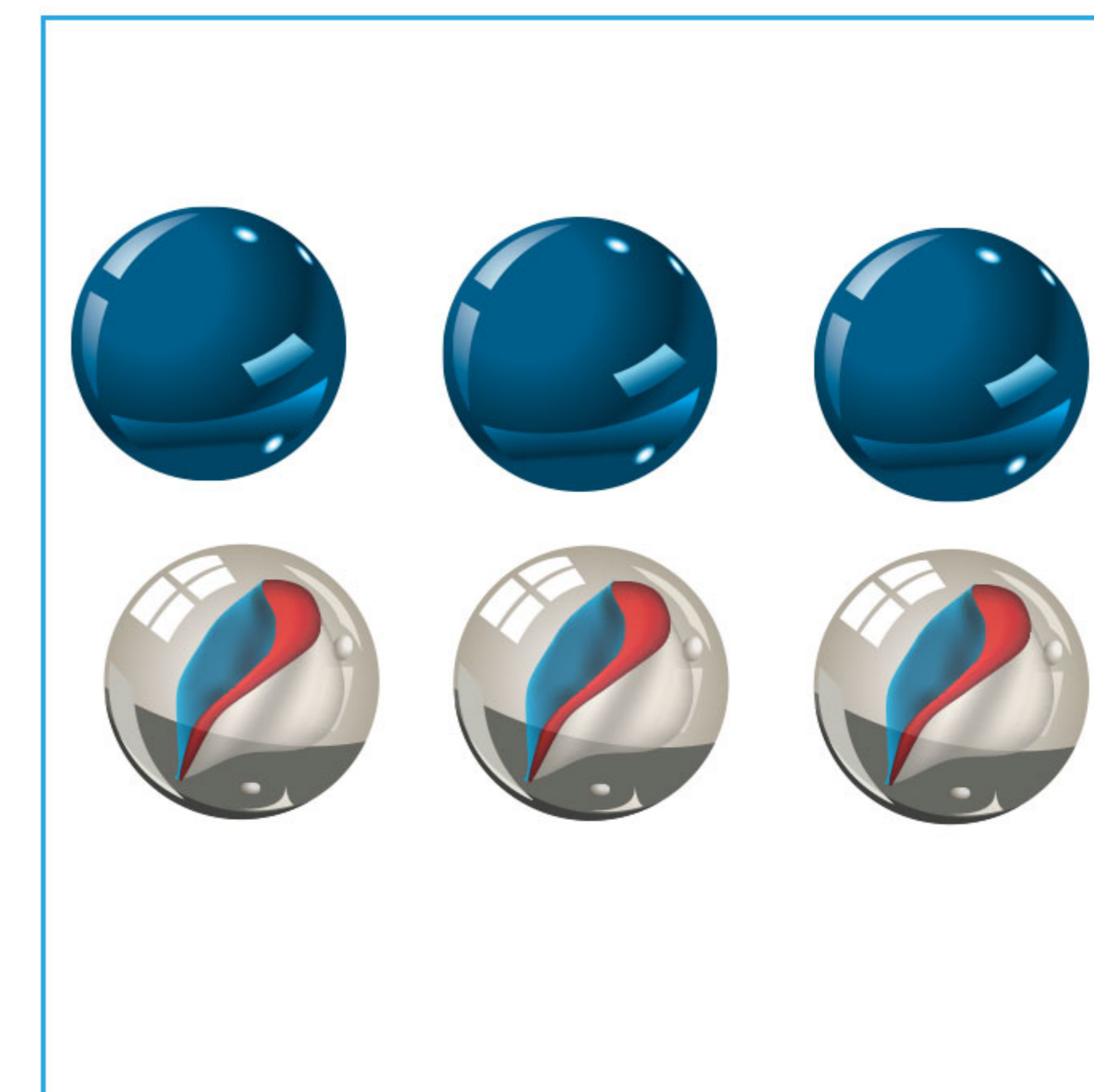
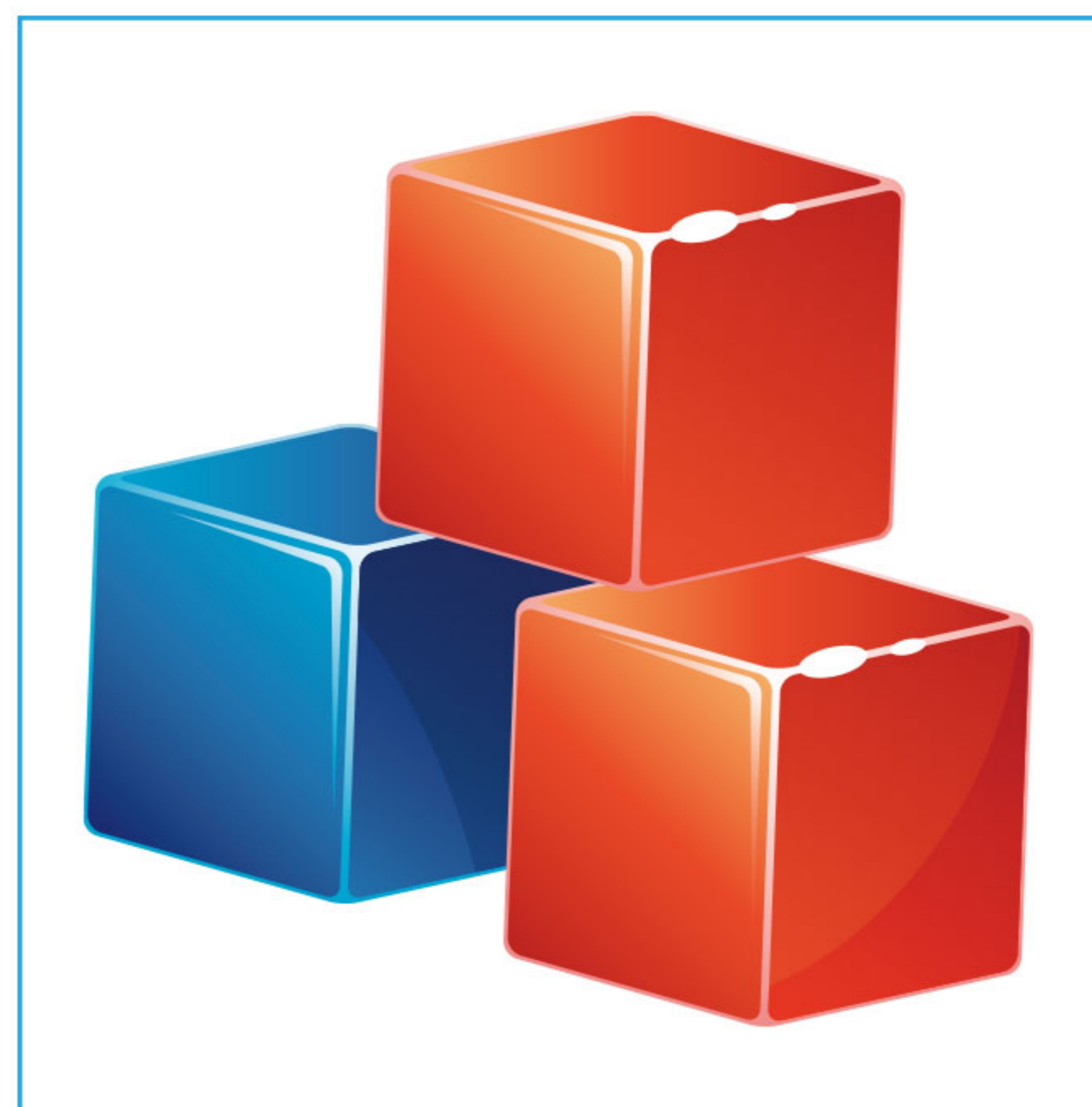



Rodea el conjunto de objetos que representa la suma

$$1 + 1 = 2$$

